

IPC Accessories Installation Guide

2019-08-28

Box camera mount

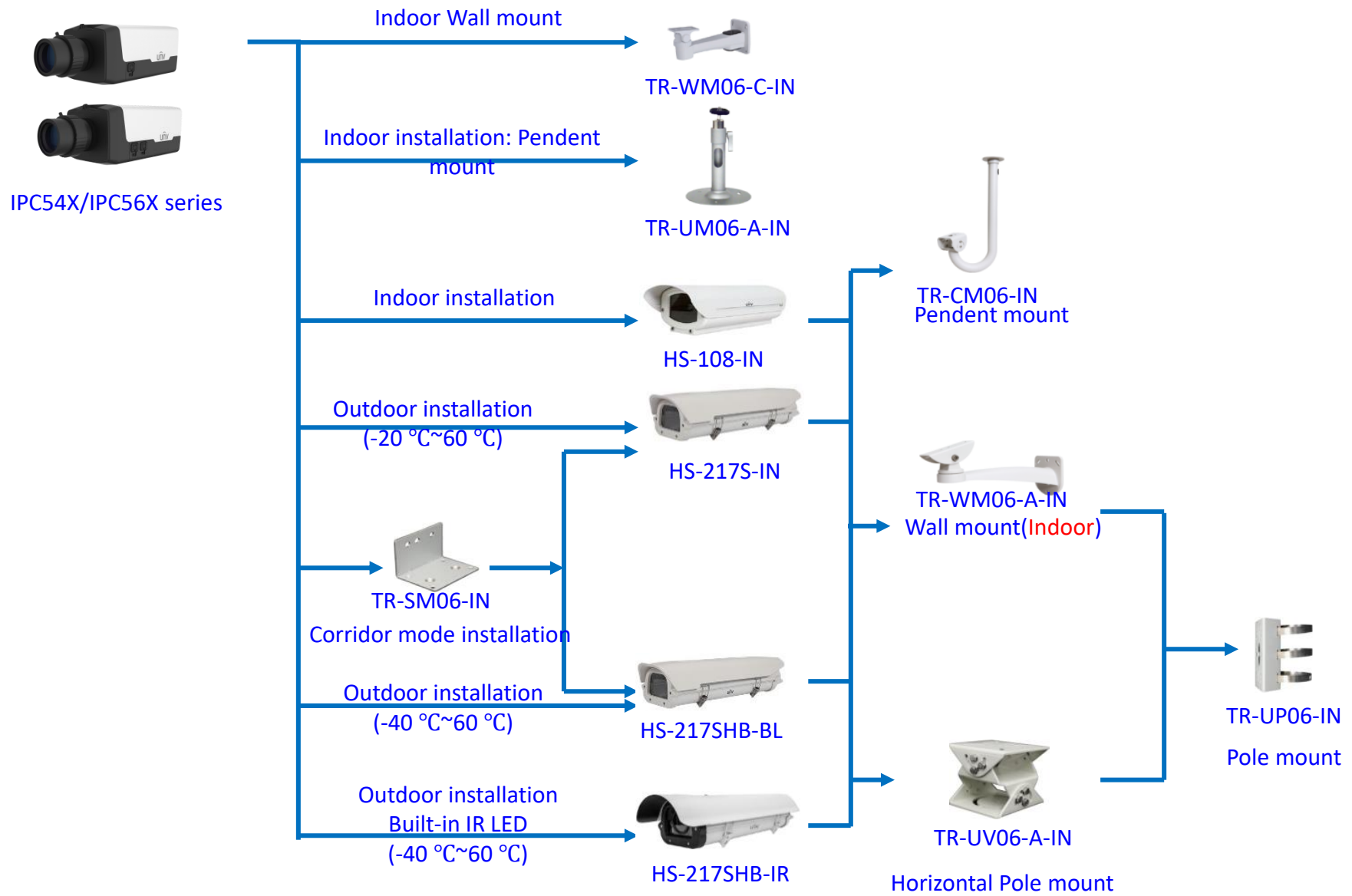

Box camera mount



IPC54X/IPC56X series

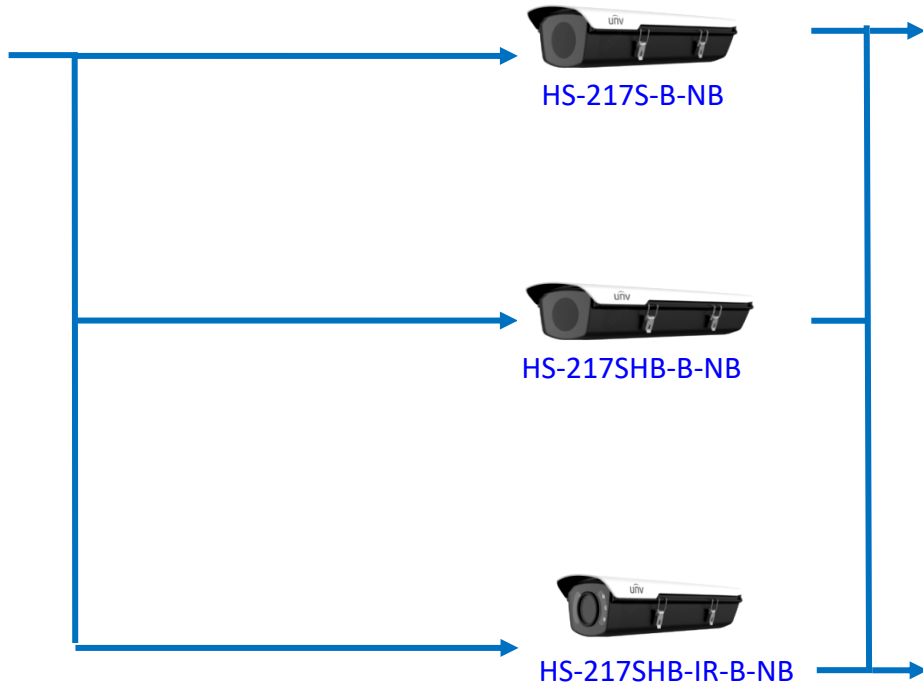

HS-217S-B-NB



HS-217SHB-B-NB



HS-217SHB-IR-B-NB



TR-WM06-I-IN
Wall mount



TR-UV06-A-IN
Horizontal Pole
mount



TR-UP06-IN
Pole mount

Dome camera mount



IPC323X series

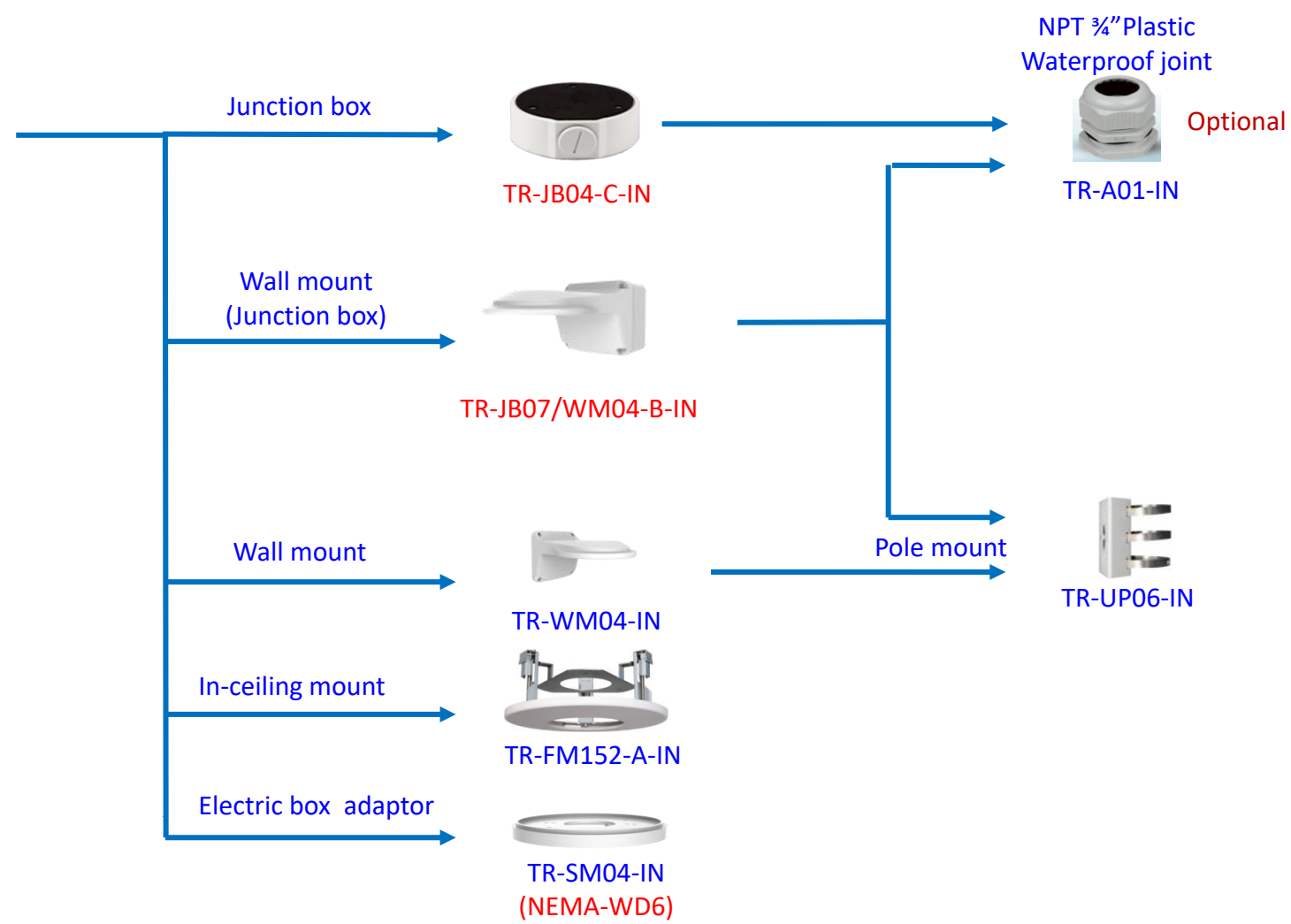

Dome camera mount

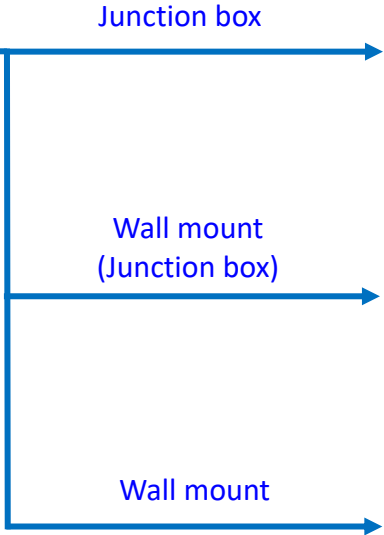

NPT 3/4" Plastic
Waterproof joint



Optional

Pole mount



TR-UP06-IN

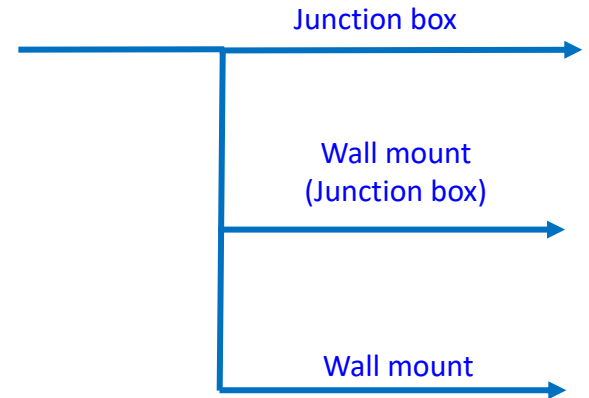

NPT 3/4" Plastic
Waterproof joint



Optional

Pole mount



TR-UP06-IN

Dome camera mount

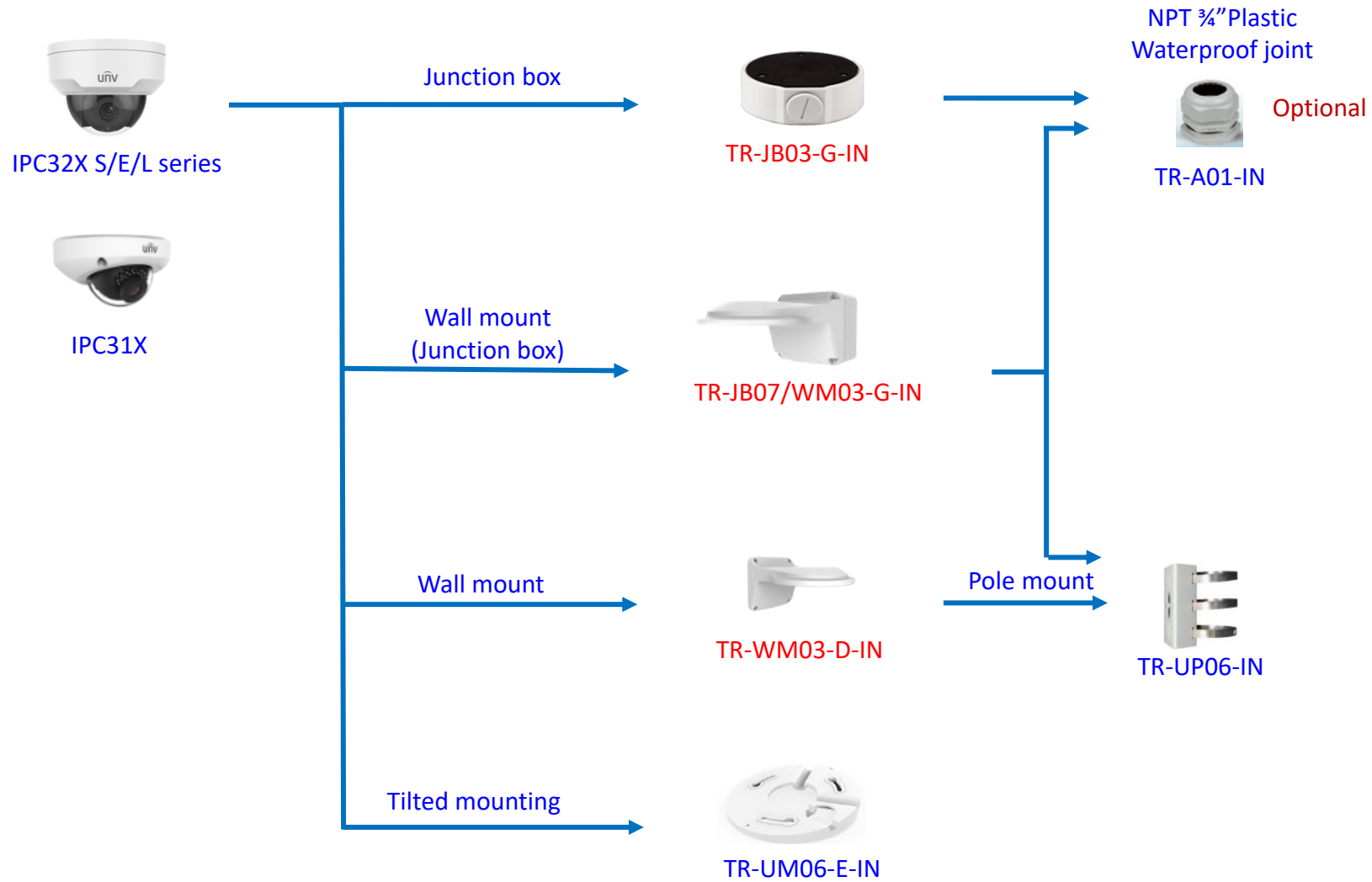

Fisheye camera mount



Dome camera Indoor pendent mount

*Release: 2019Q1



Junction box

IPC323X series + TR-JB04-C-IN

PRIME series
IPC363X + TR-JB03-H-IN
PRIME series
IPC361X S/E

EASY series
IPC361XL + TR-JB03-I-IN

IPC32X S/E/L
series + TR-JB03-G-IN
IPC31X

868 fisheye + TR-JB04-D-IN

814 fisheye + TR-JB03-H-IN

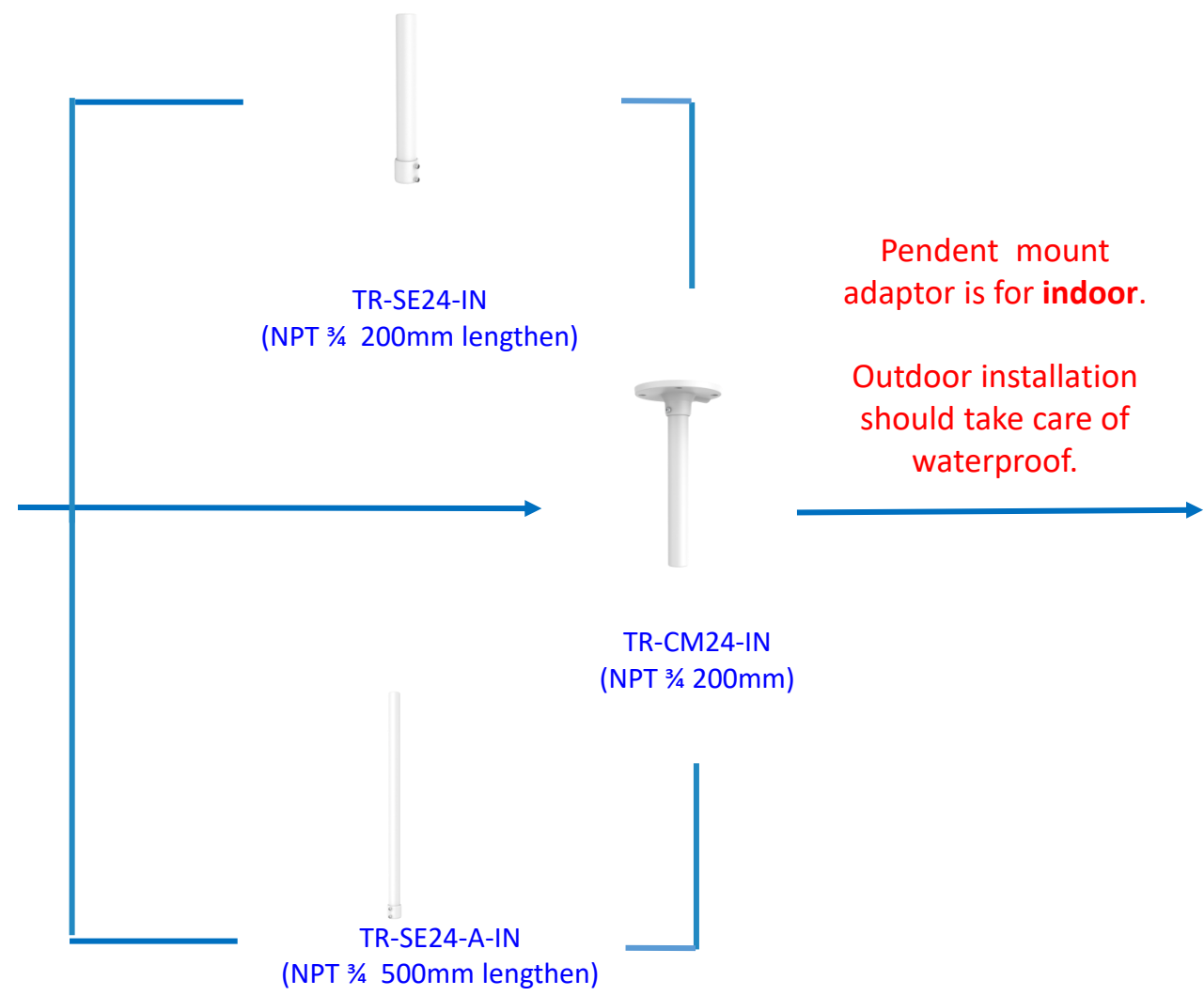

Indoor pendent mount

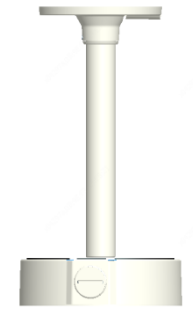

Bullet camera mount



IPC232X/ 222X series



IPC74X series



26X series



IPC252 series

Junction box



TR-JB07-D-IN

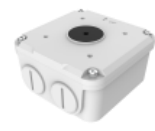

TR-JB06-A-IN



TR-UP06-B-IN

Pole mount

Junction box



TR-JB07-D-IN



TR-UP06-B-IN

Pole mount

NPT 3/4" Plastic Waterproof joint

Optional



TR-A01-IN

Pole mount

Recommended side outlet for cable



TR-UP06-C-IN

NPT 3/4" Plastic Waterproof joint

Optional



TR-A01-IN

Pole mount

Recommended side outlet for cable



TR-UP06-C-IN

Bullet camera mount



IPC2C22

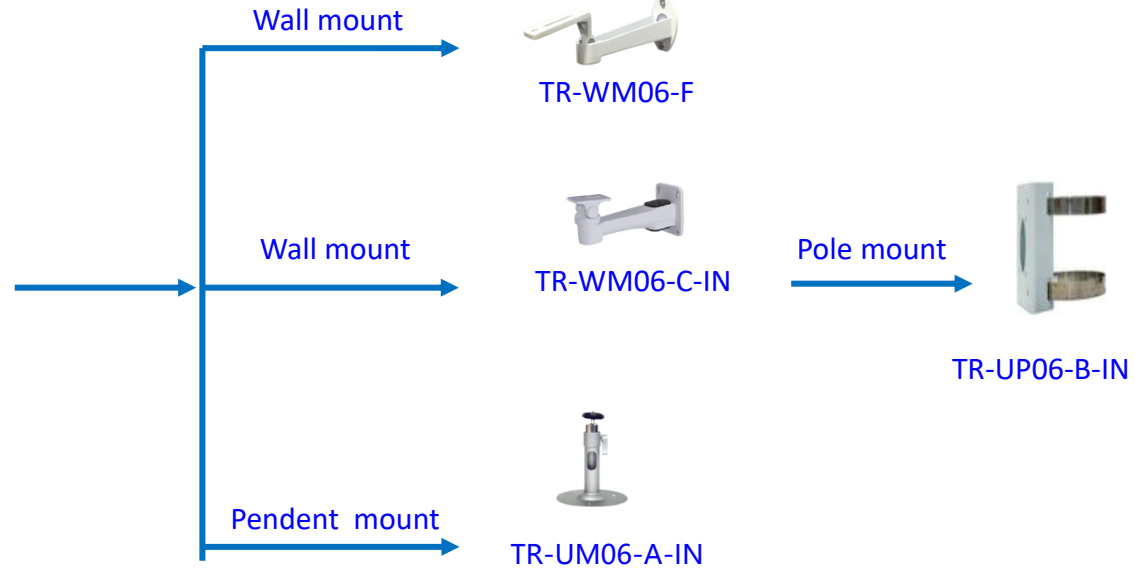

Mini Bullet camera mount

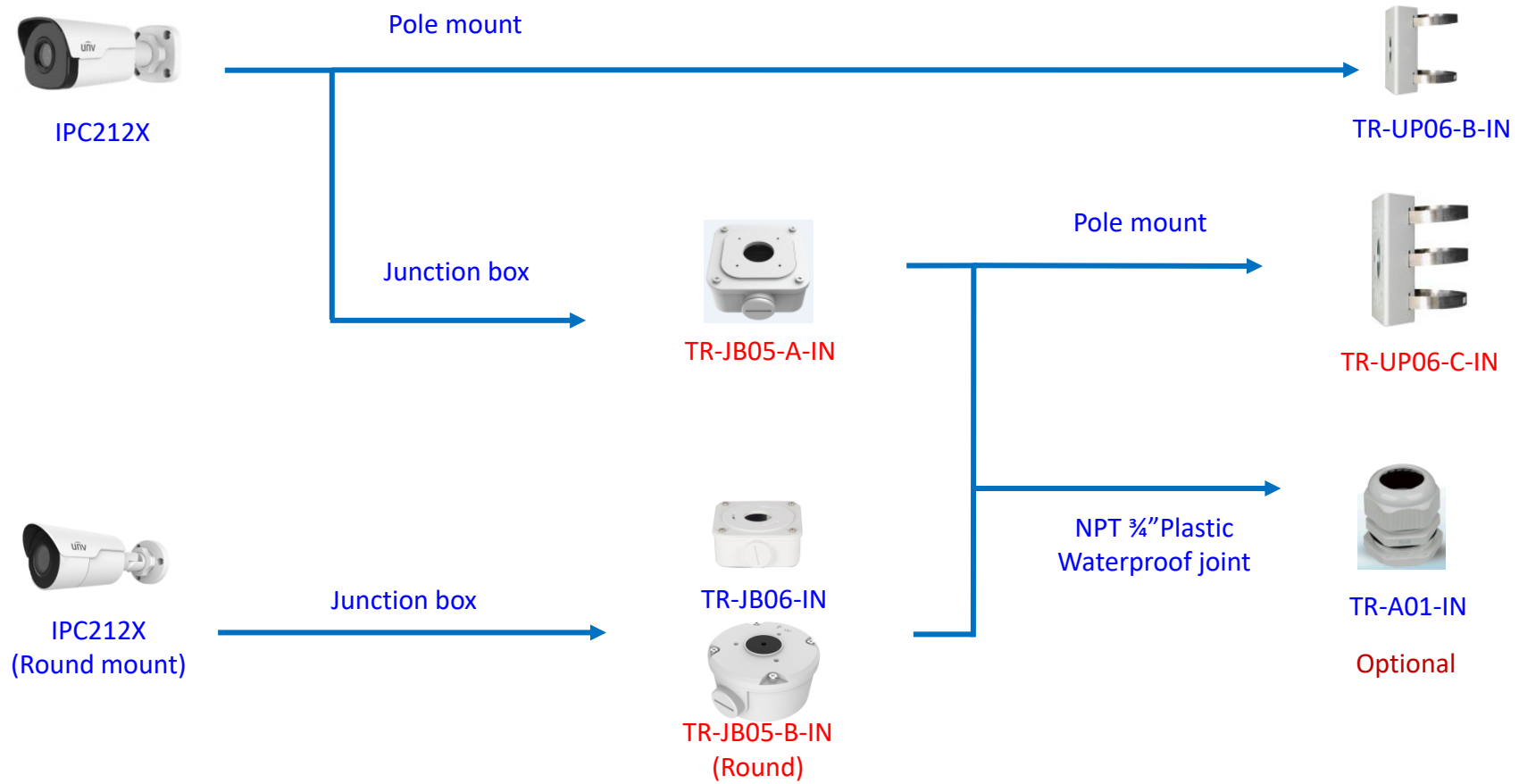

PTZ camera mount



IPC62xx Series
IPC63xx Series

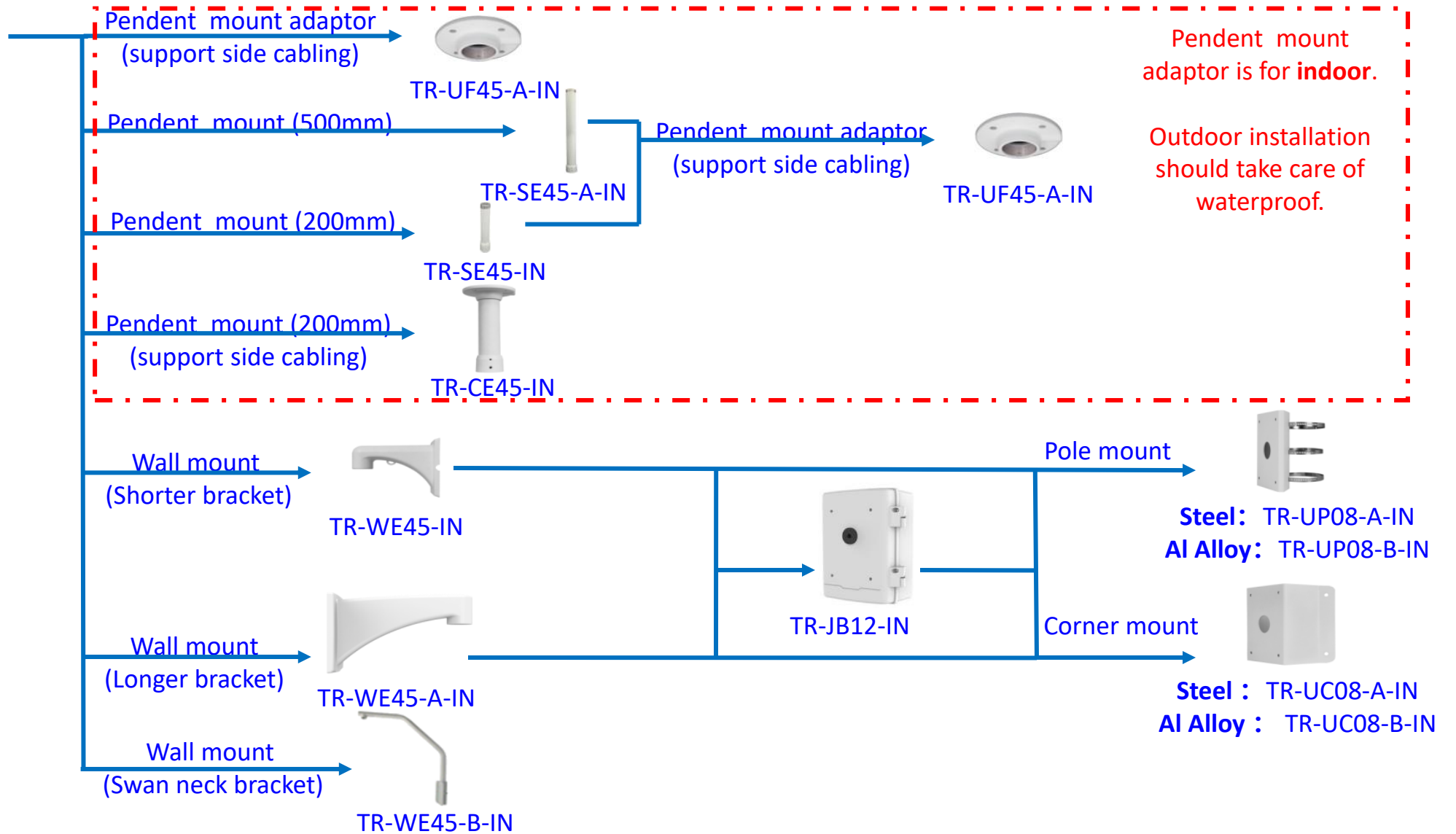

PTZ camera mount

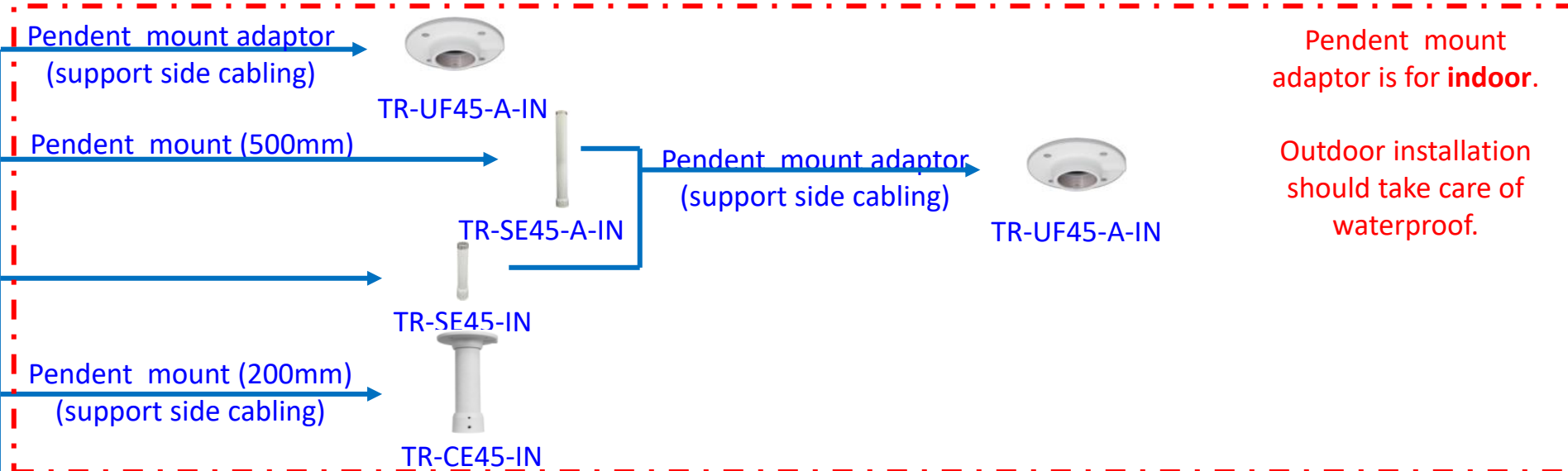

Pendant mount adaptor is for **indoor**.

Outdoor installation should take care of waterproof.

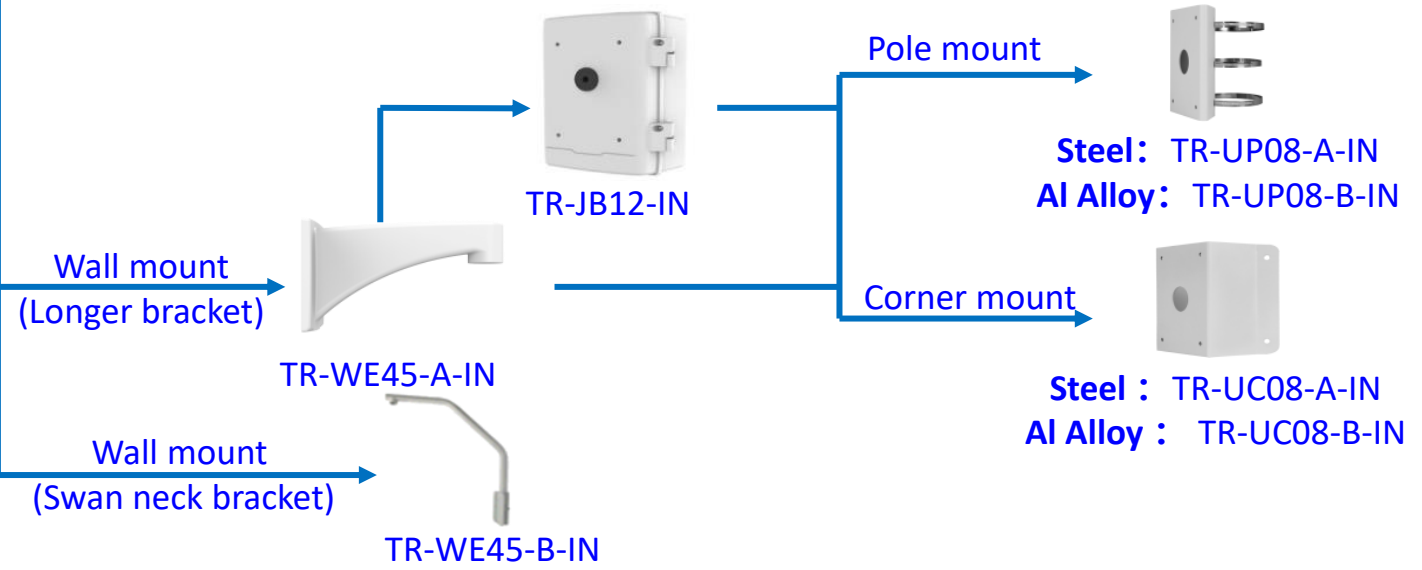

Indoor PTZ camera mount

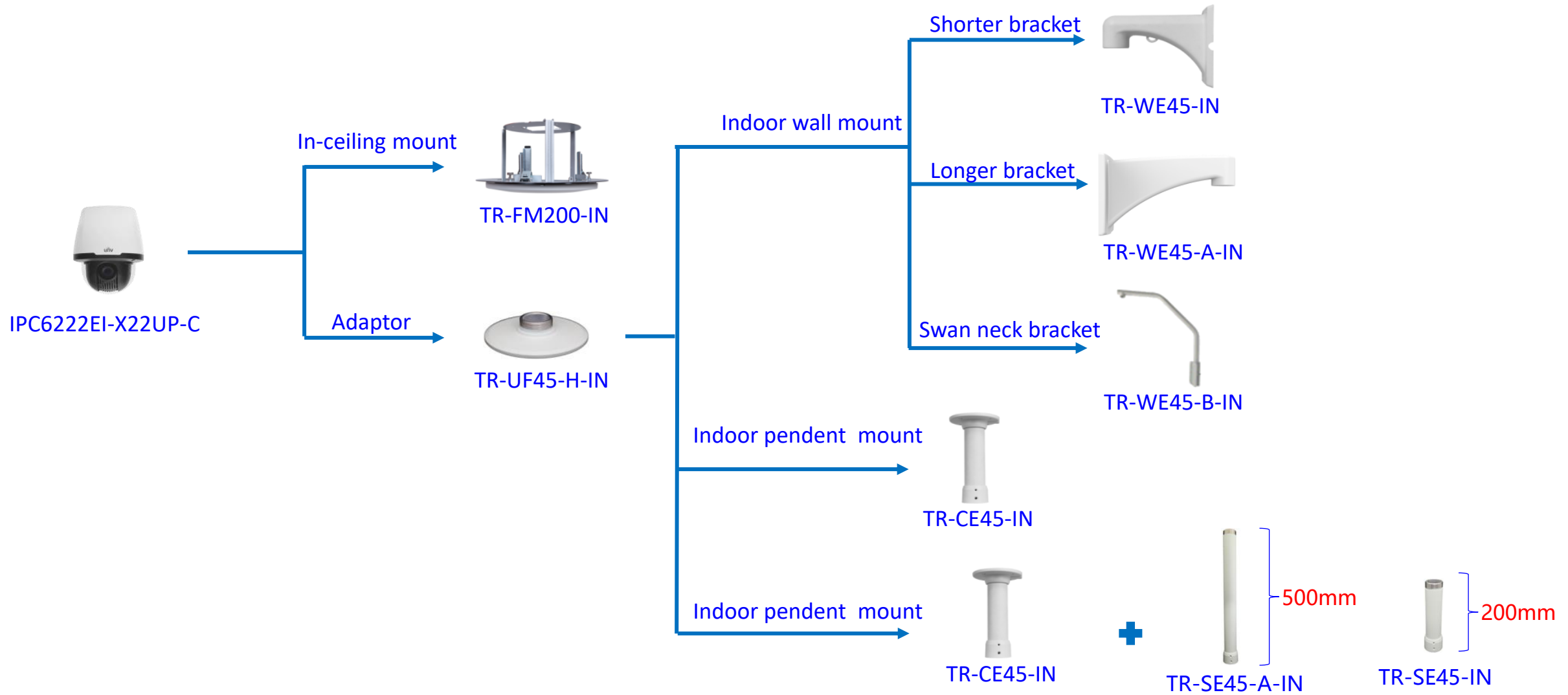

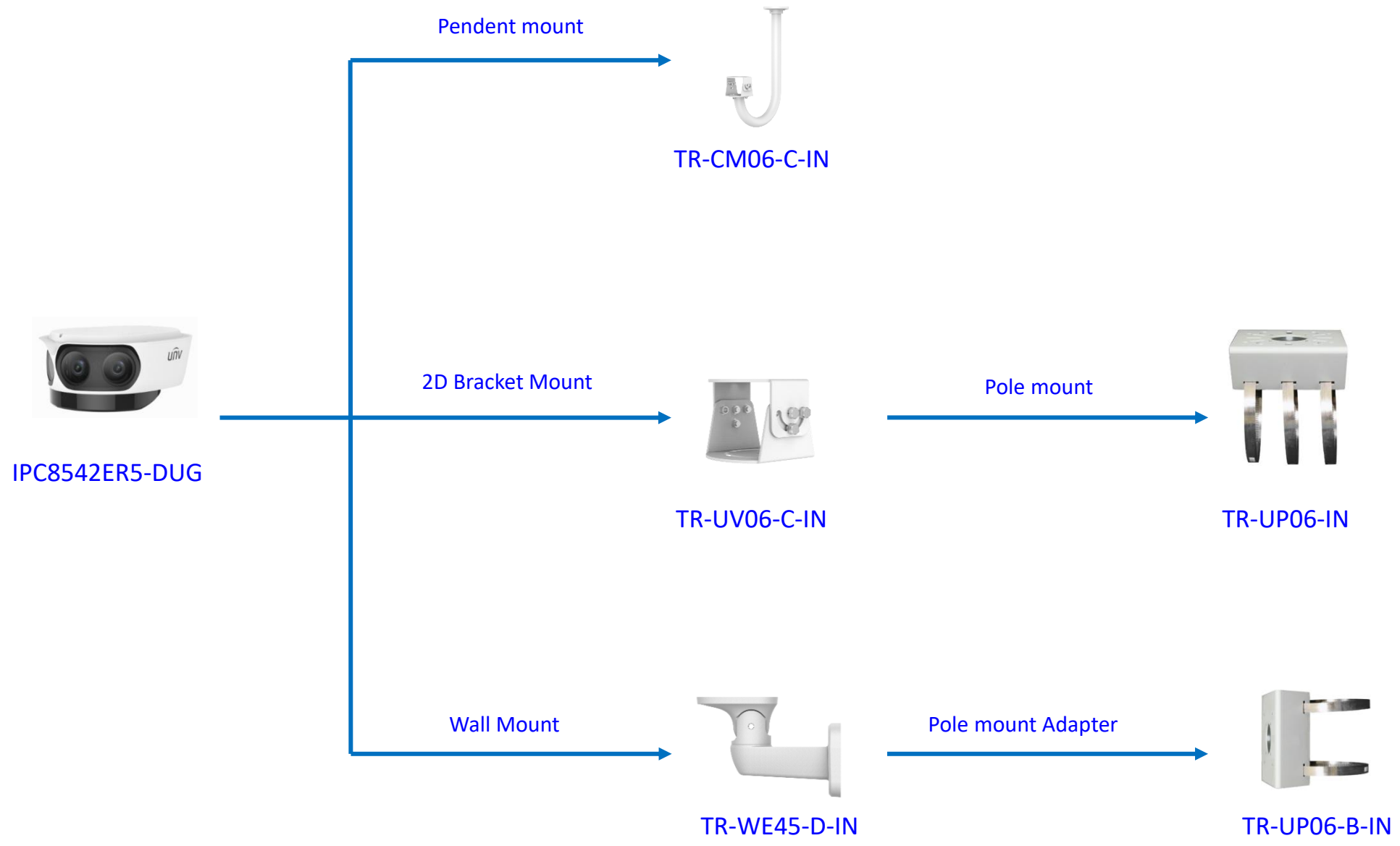

The logo for Uniview, featuring the word "uniview" in a white, lowercase, sans-serif font. A thin white line with rounded ends frames the text, extending horizontally to the left and right. A small white arc is positioned above the letter 'i'.

uniview