

Camera Installation Guide

Thank you for purchasing our product. If there are any questions, or requests, please do not hesitate to contact the dealer.

Notice

- The contents of this document are subject to change without prior notice. Updates will be added to the new version of this manual. We will readily improve or update the products or procedures described in the manual.
- Best effort has been made to verify the integrity and correctness of the contents in this document, but no statement, information, or recommendation in this manual shall constitute formal guarantee of any kind, expressed or implied. We shall not be held responsible for any technical or typographical errors in this manual.
- The product appearance shown in this manual is for reference only and may be different from the actual appearance of your device.
- This manual is a guide for multiple product models and so it is not intended for any specific product.
- Due to uncertainties such as physical environment, discrepancy may exist between the actual values and reference values provided in this manual. The ultimate right to interpretation resides in our company.
- Use of this document and the subsequent results shall be entirely on the user's own responsibility.

Environmental Protection

This product has been designed to comply with the environmental protection requirements. The storage, use, and disposal of this product must meet the applicable national laws and regulations.

Preface

Audience

This manual is intended for:



- Surveillance system planners
- Field technical support and servicing engineers
- Software installation, configuration, and servicing administrators
- Product users

Conventions

Document Conventions

Convention	Description
Boldface font	Commands, keywords, parameters and GUI elements such as window, tab, dialog box, menu, button, etc.
<i>Italic font</i>	Variables for which you supply values.
>	Separate a series of menu items, for example, Device Management > Add Device .



Symbols

Symbol	Description
 WARNING!	Contains important safety instructions and indicates situations that could cause bodily injury.
 CAUTION!	Means reader be careful and improper operations may cause damage or malfunction to product.
 NOTE!	Means useful or supplemental information about the use of product.

Safety and Compliance Information

Conventions Used Symbol

The symbols in this manual are shown in the following table. They are used to remind the reader of the safety precautions during equipment installation and maintenance.

Safety Symbol	Description
	Generic alarm symbol: To suggest a general safety concern.
	ESD protection symbol: To suggest electrostatic-sensitive equipment.
	Electric shock symbol: To suggest a danger of high voltage.

Safety Information



WARNING!

Installation and removal of the unit and its accessories must be carried out by qualified personnel. You must read all of the Safety Instructions supplied with your equipment before installation and operation.

- If the product does not work properly, please contact your dealer. Never attempt to disassemble the camera yourself. (We shall not assume any responsibility for problems caused by unauthorized repair or maintenance.)
 - To reduce the risk of fire or electrical shock, do not expose this product to rain or moisture.
 - This installation should be made by a qualified service person and should conform to all the local codes.
 - Please make sure that the ceiling can support more than 50(N) Newton gravities if the camera is fixed to the ceiling.
 - Make sure the power supply voltage is correct before using the camera.
 - Do not drop the camera or subject it to physical shock.
 - Do not touch sensor modules with fingers. If cleaning is necessary, use a clean cloth with a bit of ethanol and wipe it gently. If the camera will not be used for an extended period of time, put on the lens cap to protect the sensor from dirt.
 - Do not aim the camera lens at the strong light such as sun or incandescent lamp. The strong light can cause fatal damage to the camera.
 - The sensor may be burned out by a laser beam, so when any laser equipment is being used, make sure that the surface of the sensor not be exposed to the laser beam.
 - While shipping, the camera should be packed in its original packing.
-



Caution: Fiber optic ports – optical safety.



Never look at the transmit laser while the power is on. Never look directly at the fiber ports and the fiber cable ends when they are powered on.

Caution: Use of controls or adjustments to the performance or procedures other than those specified herein may result in hazardous laser emissions.

Regulatory Compliance

FCC Part 15

This equipment has been tested and found to comply with the limits for digital device, pursuant to part 15 of the FCC Rules. These limits are designed to provide reasonable protection against harmful interference when the equipment is operated in a commercial environment. This equipment generates, uses, and can radiate radio frequency energy and, if not installed and used in accordance with the instruction manual, may cause harmful interference to radio communications. Operation of this equipment in a residential area is likely to cause harmful interference in which case the user will be required to correct the interference at his own expense.

This product complies with Part 15 of the FCC Rules. Operation is subject to the following two conditions:

1. This device may not cause harmful interference.
2. This device must accept any interference received, including interference that may cause undesired operation.

LVD/EMC Directive



This product complies with the European Low Voltage Directive 2006/95/EC and EMC Directive 2004/108/EC.

WEEE Directive–2002/96/EC



The product this manual refers to is covered by the Waste Electrical & Electronic Equipment (WEEE) Directive and must be disposed of in a responsible manner.

Contents

1 Overview	1-1
2 Installation	2-1
Mounting Optical Module	2-2
Box Camera	2-2
PTZ Dome Camera	2-3
Wall Mount	2-3
Mounting Accessories	2-3
PTZ Dome Camera	2-4
Box Camera	2-7
Bullet Camera	2-9
Fixed Dome Camera	2-11
Plastic Fixed Dome	2-13
Pendant Mount	2-15
Mounting Accessories	2-15
PTZ Dome Camera	2-16
Miniature Camera	2-17
Corner Mount	2-18
Mounting Accessories	2-18
PTZ Dome Camera	2-18
Standing Pole Mount	2-19
PTZ Dome Camera	2-19
Pole Mount	2-21
Mounting Accessories	2-21
PTZ Dome Camera	2-21
In-Ceiling Mount	2-22
PTZ Dome Camera	2-22
Metal Fixed Dome Camera	2-25
Plastic Fixed Dome Camera	2-26
Ceiling mount	2-27
Mounting Accessories	2-27
Indoor PTZ Dome Camera	2-27
Fixed Dome Camera	2-29
Waterproof Components for an RJ-45 Plug	2-37
3 Cable Connection for External Device	3-39
Cables and Adapters	3-39
Common Cables and Adapters	3-39
4 Pin Z/F Interface	3-40
Wiring	3-41

Cable Requirements.....	3-41
Video Cable	3-41
Audio Cable	3-42
Power Cable	3-43
RS-485 Serial Cable.....	3-44
Alarm Cable	3-45
Network Cable.....	3-45
Optical fiber.....	3-45
Ground Wire.....	3-47
Cable Connection.....	3-47
Connecting to PTZ Cameras through an RS-485 Port in PTZ Control Mode.....	3-47
Connecting to a Third-Party Device through an RS-485 Port in Transparent Channel Mode.....	3-48
Connecting to Alarm Input/Output Device	3-48
4 Lightning Protection and Grounding.....	4-1
Outdoor Protection Box.....	4-1
Lightning Protection.....	4-1
External Protection.....	4-1
Cable Protection.....	4-2
Inner Protection	4-2
Ground a Device.....	4-4
5 Waterproof Measure	5-1
6 Solutions for Common Problem.....	6-2
How to Adjust Back Focus.....	6-2
System does not Prompt You to Install ActiveX for Your First Login on Windows 7	6-3
Fail to Install ActiveX.....	6-3
You Cannot View Live Video After Your First Login.	6-4

1 Overview

This manual introduces the installation of IP cameras (referred to as cameras in this manual) and the recommended requirements of the cables. Please follow the instructions to take lightning protection measures, ground the device and choose the proper housings for your cameras.

Read through this manual and follow the instructions to mount your camera efficiently.

2 Installation





You need some mount accessories (such as wall mount brackets, pendant mount brackets and in-ceiling mount brackets) to install your cameras. For more details about these accessories, see the recommended list of your dealer. Before the installation, please prepare some mounting tools as required in advance.

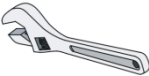
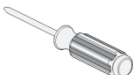
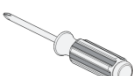

WARNING!

- To prevent screws from loosening and avoid device damage during installation, do not knock the device.
- Make sure the mounting cables are long enough to mount your cameras. Do not overbend the cables, otherwise, the connector may loose or be damaged.
- Transport the device with packing box. To prevent the cable connector from loosing or being damaged, do not hold the camera by its tail cables.

Table 2-1 Mounting Tool

Tool	Figure
Shifting wrench	
Straight screwdriver	
Cross screwdriver	
Electric impact drill	
Hammer	
Marking pen	
Hex L-key	

Mounting Optical Module

Box Camera

Mounting SFP module



NOTE!

Wear an anti-static wrist strap during your installation (connect the other end of the strap to a proper grounding point). Or you can wear anti-static gloves if there is not a proper grounding point.

To mount an SFP optical module (taking two-fiber bidirectional as an example), perform the following steps:

1. Remove the slot dustproof cover.

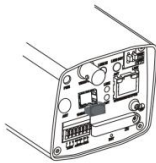

2. Insert the recommended SFP optical module.



3. Connect the optical fiber plug and the optical module.

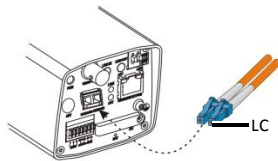

Mounting Wi-Fi antenna

Only some models support Wi-Fi.

1. Mount the Wi-Fi antenna, and check that the antenna is in position. Aim the thread end of the Wi-Fi antenna at the bolt of the antenna port.

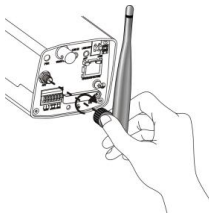

2. Adjust the direction of the Wi-Fi antenna as required.

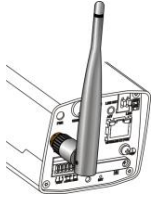

PTZ Dome Camera

Mounting SFP module

1. Remove the dustproof cover inside the tail cable unit.

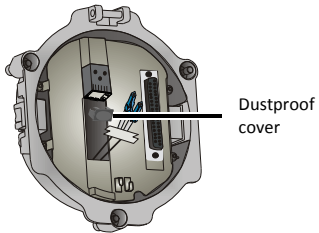

2. Insert the recommended SFP optical module.

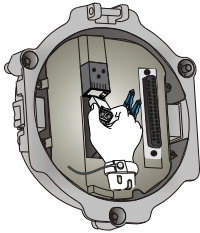

3. Connect the optical fiber plug and the optical module.

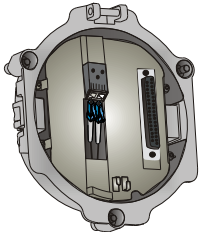

Wall Mount

Mounting Accessories

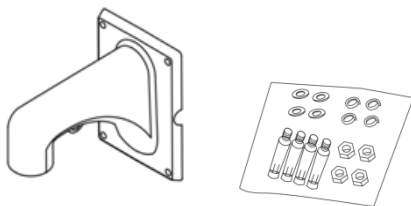

PTZ Dome Camera

Mounting bracket

1. Locate the positions of the holes.
 - a. Mark the positions of the holes by referring to the mount points of the bracket.
 - b. Lead the cables to be connected out of wall holes.

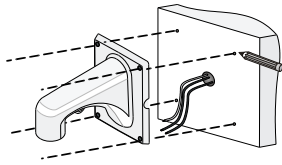

2. Drill holes on the wall.

Select a drill bit matching the outer diameter of the expansion bolt. For the hole depth, refer to the bolt length.

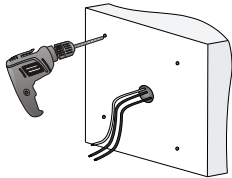

3. Knock the expansion bolts, and verify that they are tightened up.

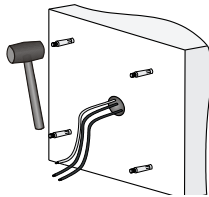

4. Screw-in the bracket adapter (G1 ½ male thread) to the connector of the wall mount bracket.

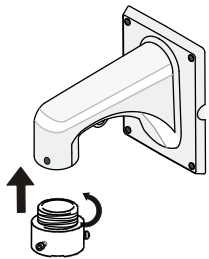

5. Tighten the screws (M4) at the bracket connector.

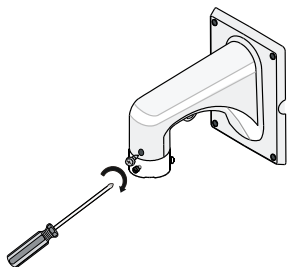

Mounting dome unit (for cameras with tail cable unit)

1. Lead the tail cable through the bracket, and push up.

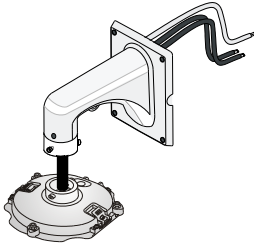

2. Slide the camera holder into the inner track and turn the tail cable unit till it is blocked by the bracket adapter screw. And then tighten the screws.

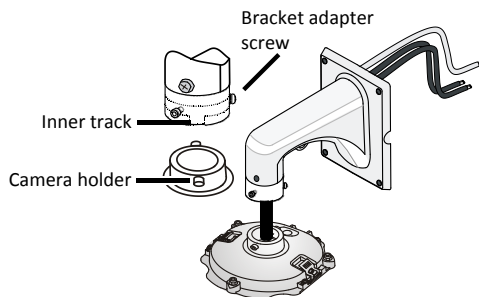

3. Fasten the bracket to the four expansion bolts on the wall with flat washers, spring washers, and nuts.

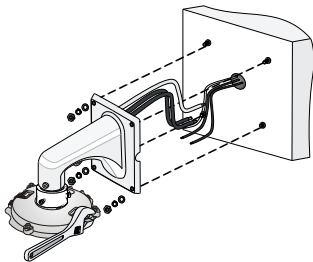

4. Hang one end of the safety rope to the camera and the other to the bracket before mounting the dome.
5. Attach the tail cable unit on the hook with the camera perfectly aligned with the three positioning pilot pillars, push the dome camera in place, and then secure the three stainless screws.

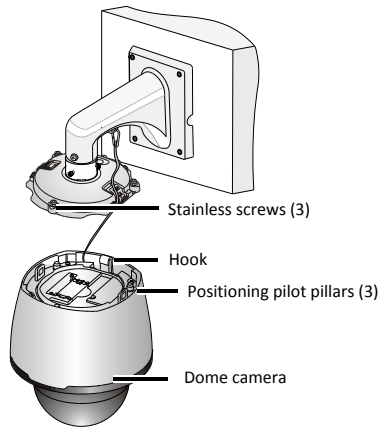

6. Mount the top sun shield.

Combine the left and right halves of the top sun shield by aligning them concurrently with the triangle icon of the dome. Then, attach them downwards on the dome.

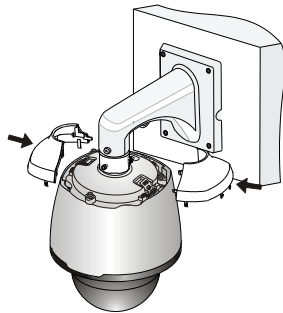

Mounting dome unit (for cameras without tail cable unit)

1. Attach the safety wire to the bracket and then lead the tail cables out of the bracket.

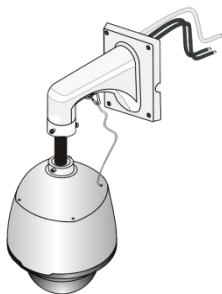

2. Attach the dome to the bracket adapter.

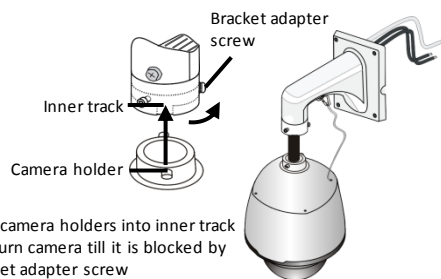

3. Secure the dome with two M5 screws.

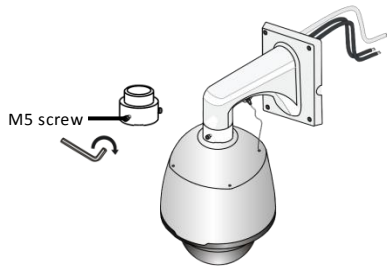

4. Connect the cables and attach the bracket to the wall with flat pads, washers and nuts.

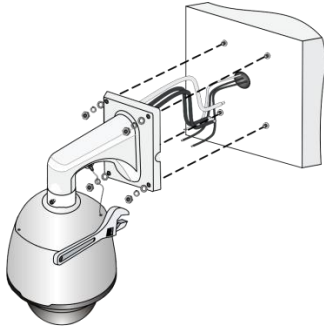

Box Camera

Mounting camera without housing

1. Locate the positions of the holes.
 - a. Locate the positions of the holes on the wall by referring to the bracket mount points.
 - b. Lead the cables across the hole on the wall.

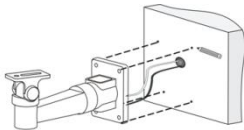

2. Drill holes on the wall.

Select a drill bit matching the outer diameter of the expansion bolts. Refer to the length of the bolts for the hole depth.

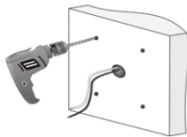

3. Install the expansions bolts.

Knock in the expansions bolts, making sure that they are fastened.



4. Mount the bracket onto the wall.
 - a. Lead cables out of the leading-out hole of the bracket.
 - b. Fix the bracket to the expansion bolts, and fasten the bracket with flat washers, spring washers, and nuts.

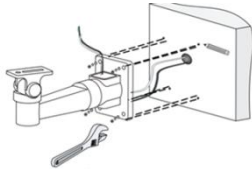

5. Mount the lens and then mount the camera onto the bracket.

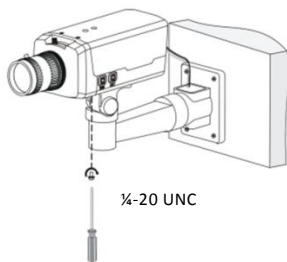

6. Perform accurate adjusting after power-on.

Mounting camera with housing

1. Select a proper housing, and remove the bottom plate.

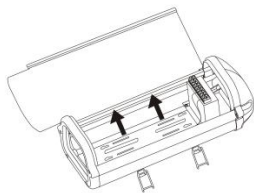

2. Fix the camera onto the bottom plate.

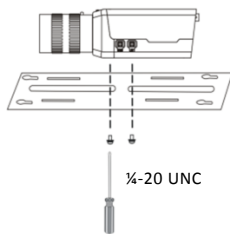

3. Fix the bottom plate and the housing.
Tighten 4 self-tapping screws through hardy holes.

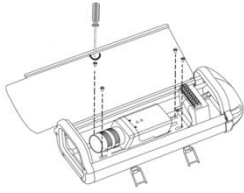

4. Fix the universal joint onto the back panel of the housing.
Loosen two screws on the universal joint so as to fix it to the housing.

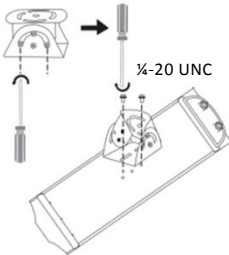

5. Encircle and fasten the bar with steel straps.
Lead cables through the pole and out of the cross arm, waiting to be connected.



6. Fix the housing on the steel straps.
 - a. Adjust the universal joint and the housing until the monitoring direction is proper.
 - b. Lead the power cable and the network cable through the cabling hole of the housing, and connect the camera.

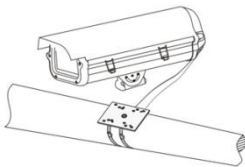

Bullet Camera

You can adopt wall mount or ceiling mount and purchase hardware accessories by yourself. The following part takes wall mount as an example. Ceiling mount is similar to wall mount and therefore is omitted here.

Locate drill holes

1. Locate the positions of the holes.
 - a. Paste installation positioning stickers on the wall and align the cross center to the wall hole.
 - b. Lead the cables out of the hole.

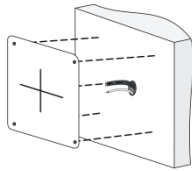

2. Drill holes on the wall.

Use a drill bit with a diameter of 6 mm or 6.5 mm to drill 30 mm-depth guide holes according to the positions marked by stickers.

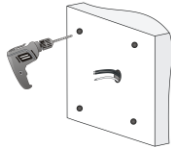

3. Install the plastic rivets of self-tapping screws.

Knock the plastic rivets into the holes and ensure that they are tightened up.

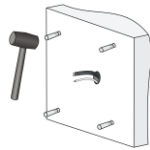

For camera without bracket

1. Mount the device onto the wall and connect all cables.

Lead self-tapping screws through the guide holes in the base and fix them on the wall by using a screwdriver.

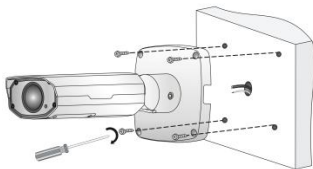

2. Adjust the monitoring direction.

Loosen the screws with 4# hex L-key (the hex L-key need to be bought separately), and then adjust the camera.

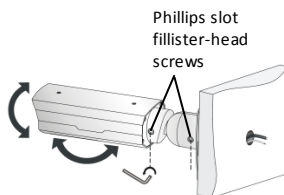

3. Power on the device, adjust the manual zoom lens to get clear image.

- a.** Open the bottom cover with the supplied torx L-key (T20).
- b.** Turn the zooming and focusing knobs of the lens to obtain clear images.

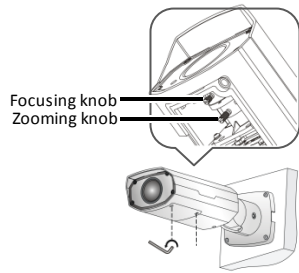

4. Power on the device, adjust the motorized zoom lens to get clear image.

For camera with bracket

1. Secure the bracket.

Lead cable out through hole in bracket.

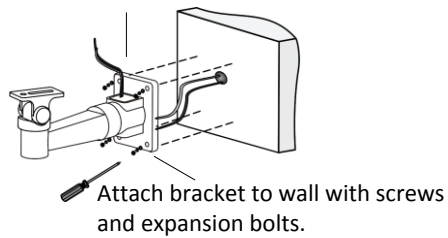

2. Adjust the monitoring direction.

Connect the cable and use waterproof tape to protect it.

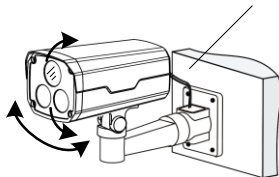

Rotate the camera vertically or horizontally as required.

3. Secure the camera to the bracket with a screw.

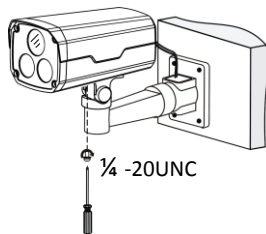

Fixed Dome Camera

1. Locate the positions of the holes.

Paste installation positioning stickers on the wall and lead the cables across the hole on the wall.

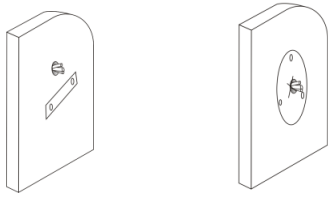

2. Drill holes on the wall.

Use a drill bit with a diameter of 6 mm or 6.5 mm to drill 30 mm-depth guide holes according to the positions marked by stickers.

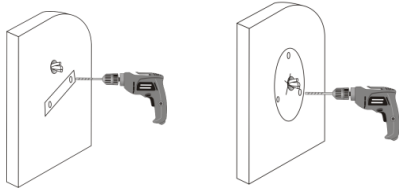

3. Mount plastic rivets of self-tapping screws.

Knock the plastic rivets into the guide holes and ensure that they are tightened up.

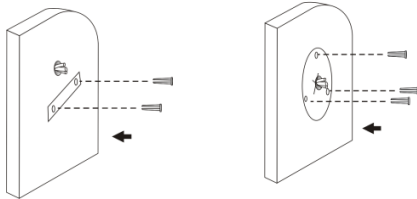

4. Mount the dome.

Connect all cables of the wall and the dome, lead self-tapping screws through the guide holes in the dome base, and fix the dome on the wall by using a screwdriver.

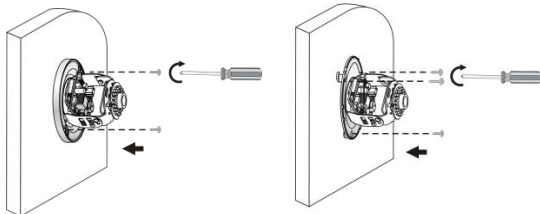

5. Adjust the monitoring direction of the lens (tighten screws after vertically adjusting the lens).

- a. Rotate the base of lens horizontally, as shown by ❶ in the following figure.
- b. After loosening the fastening screws, turn the lens vertically, as shown by ❷ in the following figure.

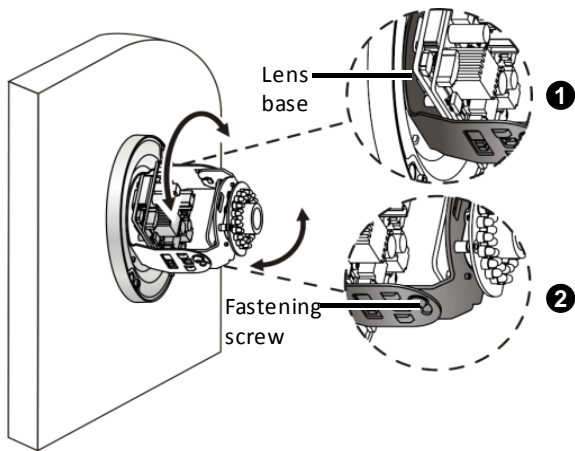

6. Mount the lining and ensure that it is tightened up.

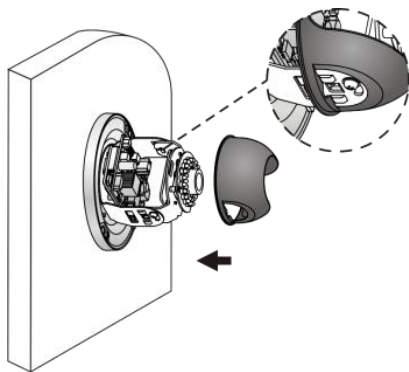

7. Mount the transparent dome housing.

- a. Align the screw holes in the base, and tighten the two cross-recessed pan-head screws on the edge of the transparent dome housing to fix it, as shown by ❶ in the following figure.
- b. Align the grooves (non-tail cable grooves) of the transparent dome housing to the buckle of the base, and push up the dome housing to fix it, as shown by ❷ in the following figure.

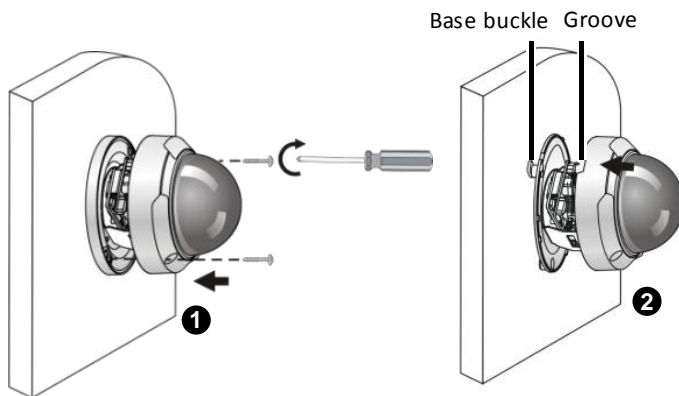

Plastic Fixed Dome

1. Secure screws to the adapter.

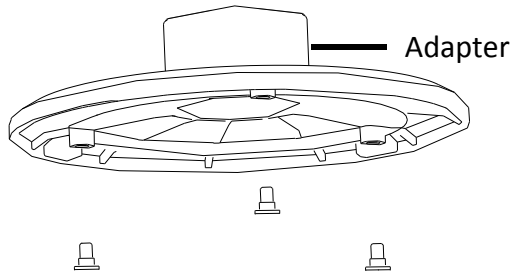

2. Attach the adapter to the mounting bracket.

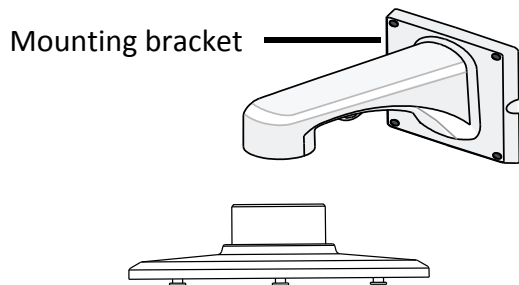

3. Secure the camera unit to the adapter and connect the cables.

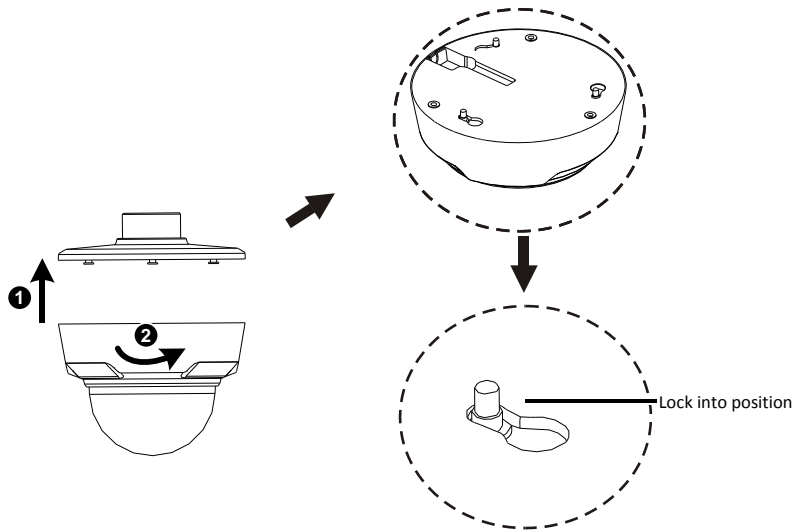

4. Remove the dome bubble.

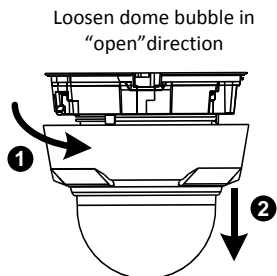

5. Adjust the monitoring direction.

Turn the lens vertically and horizontally

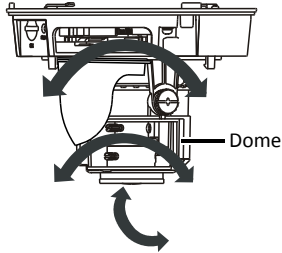

6. For manual lens, power on the device, and then turn the rotate knob to get clear image.

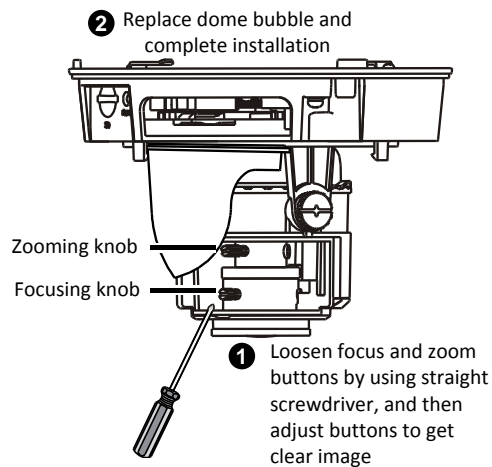

7. For automatic lens, you can adjust the image directly after power up.

Pendant Mount



WARNING!

- Pendant mount brackets are usually used indoors. If the brackets are used outdoors, you must perform waterproof measures for the cameras. We will not take the responsibility for device faulty caused by poor waterproof measures. Thanks for your cooperation.
- Customized pendant brackets must meet the waterproof requirements to prevent the brackets from water.
- Protect the tail cables from water. Do not immerse the tail cables in water.
- Protect the tail cables and do not expose the cables.
- Secure the pendant mount bracket and pole, and use silica gel to seal the device.

Mounting Accessories

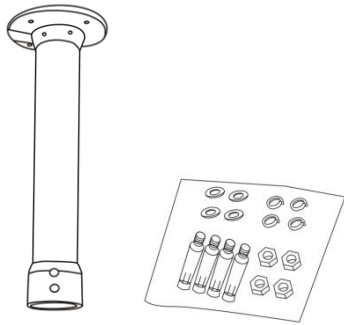

PTZ Dome Camera

Mounting the pendant bracket

1. Locate the positions of the holes.
 - a. Mark the positions of the holes by referring to the mount points of the bracket.
 - b. Lead the cable out of the hole on the wall.

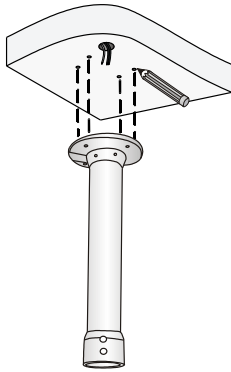

2. Select a drill bit matching the outer diameter of the expansion bolt. For the hole depth, refer to the bolt length.

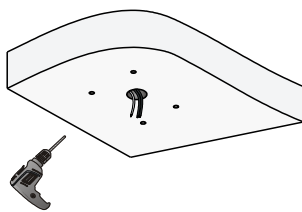

3. Knock the expansion bolts, and verify that they are tightened up.

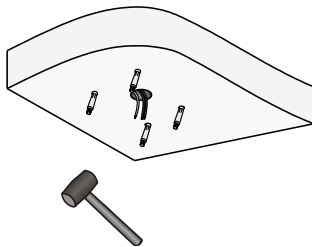

4. Screw-in the bracket adapter (G1 ½ male thread) to the connector of the pendant mount bracket.



5. Tighten the screws (M4) at the bracket.

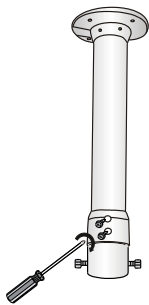

For cameras with tail cable unit

The steps to install the camera (include mounting the tail cable unit, securing the bracket to the wall and installing the camera unit) are similar to that of wall mount. For more information, see [Mounting dome unit \(for cameras with tail cable unit\)](#).

For cameras without tail cable unit

The steps to install the camera (include attaching the camera to the bracket and securing the bracket to the wall) are similar to that of wall mount. For more information, see [Mounting dome unit \(for cameras without tail cable unit\)](#).

Miniature Camera

Mounting Description

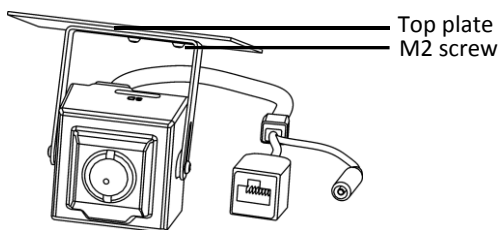

Wiring for Coaxitron

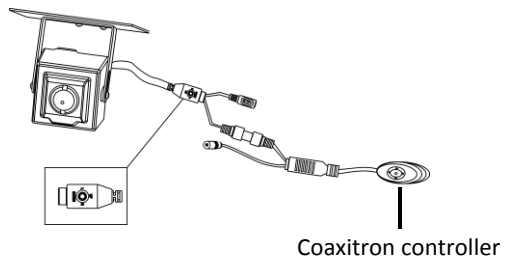

Corner Mount

Mounting Accessories

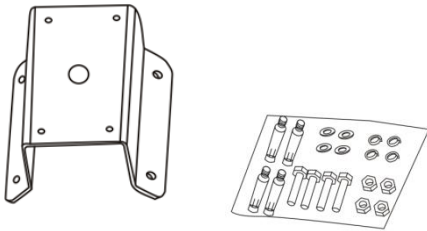

PTZ Dome Camera

Mounting accessories

1. Mark positions of holes by referring to mount points of the bracket.

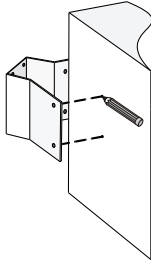

2. Drill holes on the wall.

Select a drill bit matching the outer diameter of the expansion bolt. For the hole depth, refer to the bolt length.

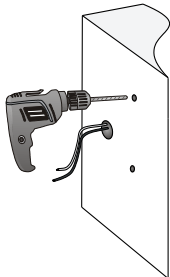

3. Knock the expansion bolts, and verify that they are tightened up.

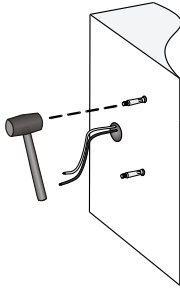

4. Mount the corner mount accessory and lead the cables out.
Fasten the corner mount accessory to four expansion bolts, and secure the accessory with flat washers, spring washers, and nuts.

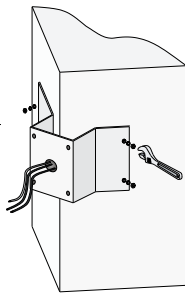

For cameras with tail cable unit

The steps to install the camera (include mounting the tail cable unit, securing the bracket to the wall and installing the camera unit) are similar to that of wall mount. For more information, see [Mounting dome unit \(for cameras with tail cable unit\)](#).

For cameras without tail cable unit

The steps to install the camera (include attaching the camera to the bracket and securing the bracket to the wall) are similar to that of wall mount. For more information, see [Mounting dome unit \(for cameras without tail cable unit\)](#).

Standing Pole Mount

PTZ Dome Camera

Using original standing pole

1. Customize the adapter so that the dome matches with the original standing pole.

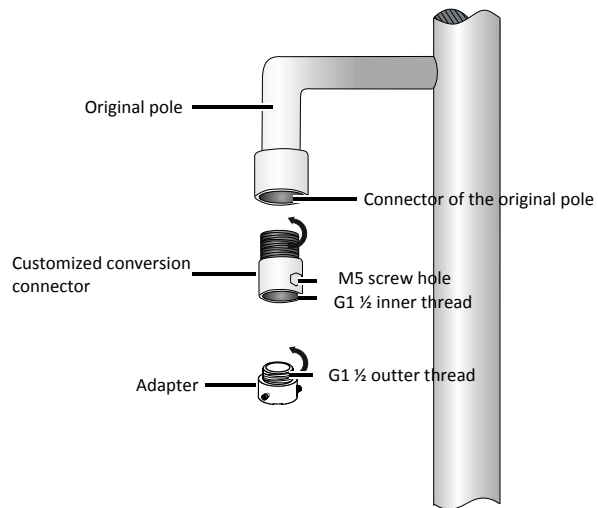

2. Connect and fasten the original standing pole to two adapters.

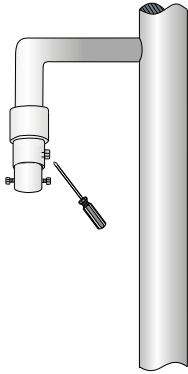

Customizing standing pole

1. Customize a standing pole to match the dome.

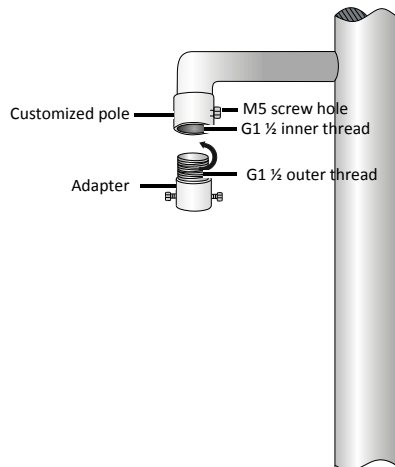

2. Connect and fasten the customized pole to the adapter.

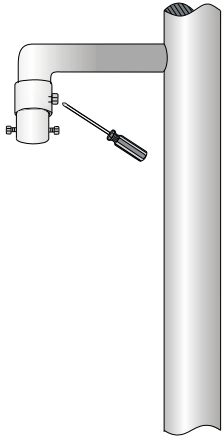

For cameras with tail cable unit

The steps to install the camera (include mounting the tail cable unit, securing the bracket to the wall and installing the camera unit) are similar to that of wall mount. For more information, see [Mounting dome unit \(for cameras with tail cable unit\)](#).

For cameras without tail cable unit

The steps to install the camera (include attaching the camera to the bracket and securing the bracket to the wall) are similar to that of wall mount. For more information, see [Mounting dome unit \(for cameras without tail cable unit\)](#).

Pole Mount

Mounting Accessories

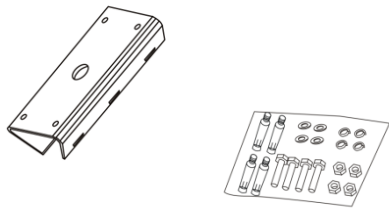

PTZ Dome Camera

Mounting accessories

1. Assemble pole mount accessories, loosen the three pole mount clamps, and then insert them into holes of the pole mount bracket.

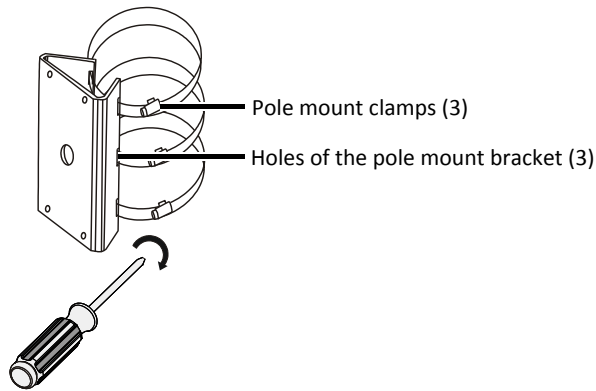

2. Tighten the clamps, and fasten the clamps to the pillar.

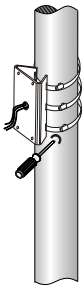

For cameras with tail cable unit

The steps to install the camera (include mounting the tail cable unit, securing the bracket to the wall and installing the camera unit) are similar to that of wall mount. For more information, see [Mounting dome unit \(for cameras with tail cable unit\)](#).

For cameras without tail cable unit

The steps to install the camera (include attaching the camera to the bracket and securing the bracket to the wall) are similar to that of wall mount. For more information, see [Mounting dome unit \(for cameras without tail cable unit\)](#).

In-Ceiling Mount

PTZ Dome Camera

1. Drill a hole in the ceiling.
 - a. Paste a hole positioning sticker of the in-ceiling bracket onto the ceiling.
 - b. Drill a proper-sized hole in the ceiling.

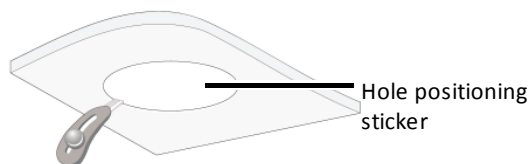

2. Put the inside bracket through the hole of the ceiling and align the inner edge of the bracket with the edge of the hole.

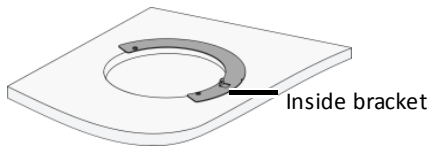

3. Fix the inside bracket and the outside bracket, align two screw holes on the outside bracket to hole positions on the inside bracket, fasten the two screws using a screwdriver, and verify that the inside bracket and the outside bracket have been fixed.

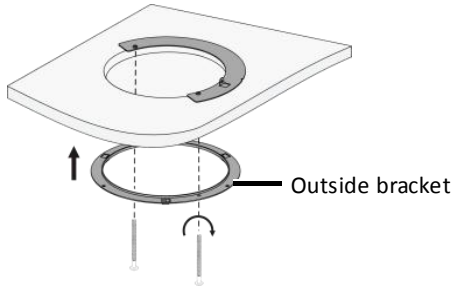

4. Mount the dome to the adapter bracket.
 - a. Lead the tail cable of the dome through the adapter bracket or out of the top hole of the adapter bracket. Then, push the dome to the adapter bracket from bottom to top.
 - b. Tighten the four screws on the top by using a screwdriver.

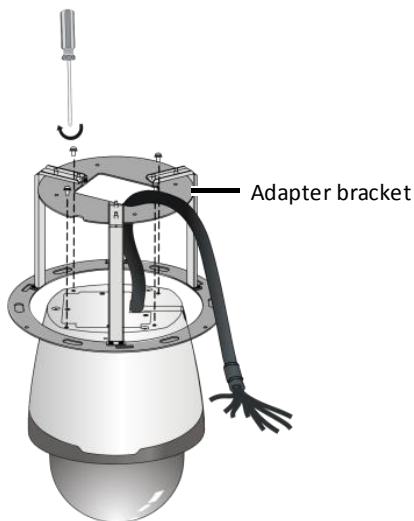

5. Fix one end of the safety rope to a hole on the adapter bracket.



6. Mount the dome to the ceiling.
 - a. Hang the other end of the safety rope onto the inside bracket on the ceiling as shown by ❶ in the following figure.
 - b. Connect all cables between the ceiling and the tail cable of the dome as shown by ❷ in the following figure.
 - c. Slowly push the adapter bracket carrying the dome upward into the ceiling as shown by ❸ in the following figure.

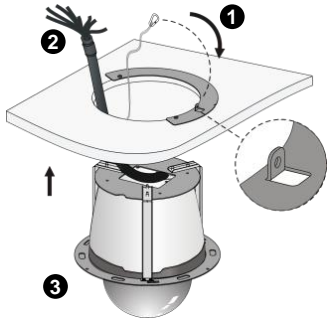

7. Fasten the adapter bracket and the outside bracket.
 - a. Aim the three square holes on the adapter bracket to the three hooks on the outside bracket.
 - b. Turn the adapter bracket, so that the adapter bracket completely hangs on the hooks on the outside bracket.



8. Tighten the locking screws on the adapter bracket by using a screwdriver, so as to fix the adapter bracket and prevent the adapter bracket from falling.

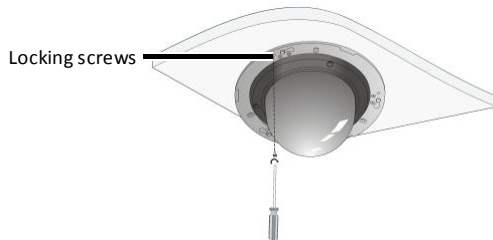

9. Attach the plastic panel to the in-ceiling bracket and make sure only the housing is visible from outside.



Metal Fixed Dome Camera

1. Drill holes in the ceiling.

Paste the hole positioning sticker of the in-ceiling bracket onto the ceiling and drill a proper-sized hole in the ceiling.

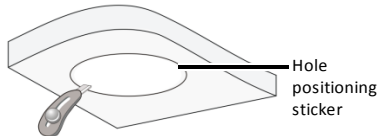

2. Mount the inside bracket to the ceiling.

Put the inside bracket through the hole of the ceiling and align the inner edge of the bracket with the edge of the hole.

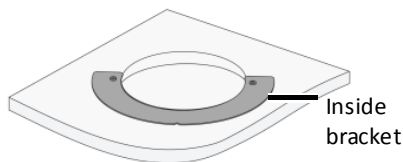

3. Fix the ceiling bracket to the in-ceiling bracket.

Lead three M4 screws through the ceiling bracket and the in-ceiling bracket, and fix them by using a cross screwdriver.

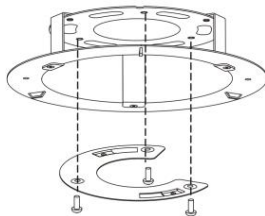

4. Refer to Step 5 to mount the camera to the ceiling bracket.

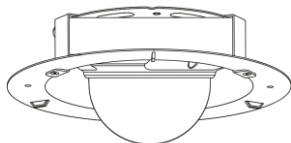

5. Mount the camera to the ceiling and fix the in-ceiling bracket.

- a. Connect all cables between the ceiling and the tail cable of the camera, as shown by ❶ in the following figure.
- b. Slowly push the in-ceiling bracket holding the camera towards the ceiling, align the screw holes of the inside bracket, and then use a screwdriver to fix the in-ceiling bracket, as shown by ❷ in the following figure.

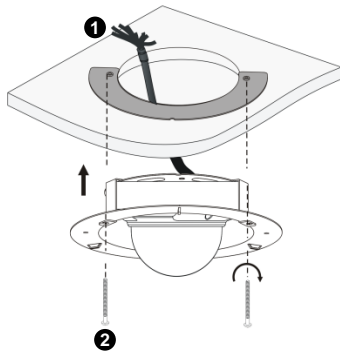

6. Mount a plastic panel to protect the camera.

Attach the plastic panel to the in-ceiling bracket and make sure only the housing is visible from outside.

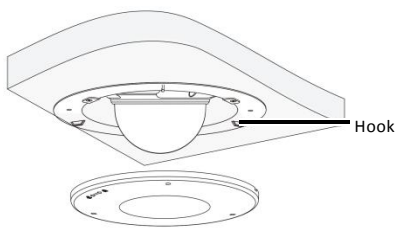

Plastic Fixed Dome Camera

To perform in-ceiling mount for plastic fixed dome cameras, you can refer to the steps for mounting the metal fixed dome cameras and replace the step 2 with following step.

1. Secure the screws to the in-ceiling bracket.

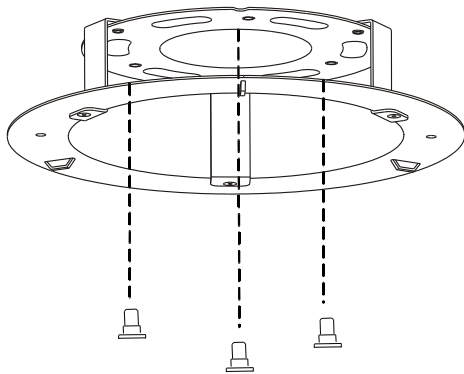

Ceiling mount

Mounting Accessories

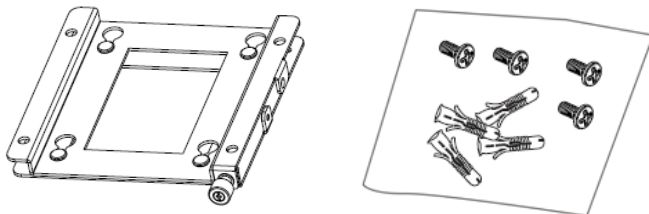

Indoor PTZ Dome Camera

1. Locate the positions of the holes. Verify that the holes on the wall align with the inner holes of the ceiling bracket.
 - a. Lead the cable through the hole on the wall.
 - b. Mark the hole by referring to mount points of the ceiling bracket.

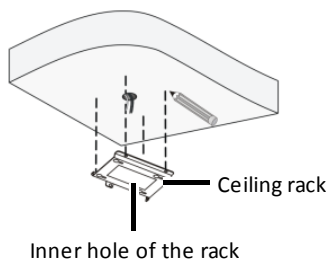

2. Drill holes (depth: about 30 mm) on the wall by using a drill bit of the diameter 6 mm or 6.5 mm.

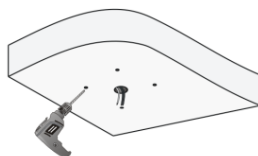

3. Mount the plastic rivets of self-tapping screws, knock the plastic rivets into the guide holes and ensure that they are tightened up.

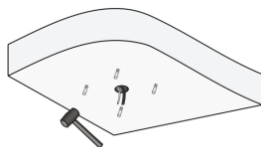

4. Mount the ceiling bracket by fastening the self-tapping screws through the bracket guide holes to the ceiling.

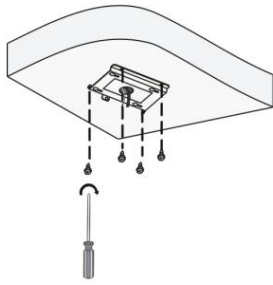

5. Mount the dome and the adapter bracket. Align the four screws of the adapter bracket with the mount points of the dome, and tighten the screws by using a screwdriver.

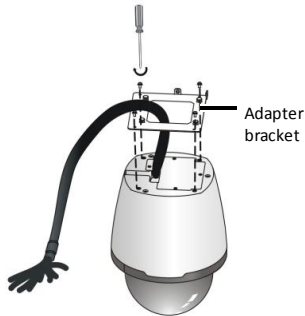

6. Fasten one end of the safety rope to the adapter bracket hole.



7. Fasten the other end of the safety rope to the ceiling bracket, and connect all cables.
 - a. Align the four stepped screws of the adapter bracket with the large hardy holes, and push the stepped screws upwards.
 - b. Push the stepped screws towards the small hardy holes, verify that the adapter bracket is firmly fixed to the ceiling bracket, and tighten the captive screws.

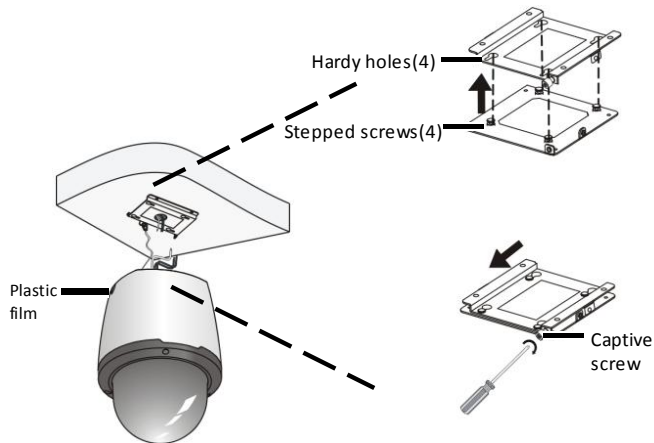

Fixed Dome Camera

Analog fixed and mini dome camera

1. Locate the positions of the holes.

Paste installation positioning stickers on the ceiling and lead the cables across the hole on the wall.

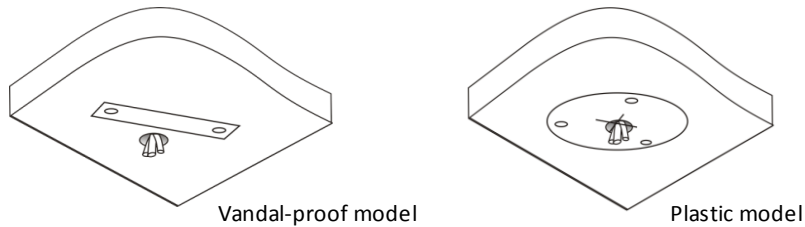

2. Drill holes on the wall.

Use a drill bit with a diameter of 6 mm or 6.5 mm to drill 30 mm-depth guide holes according to the positions marked by stickers.

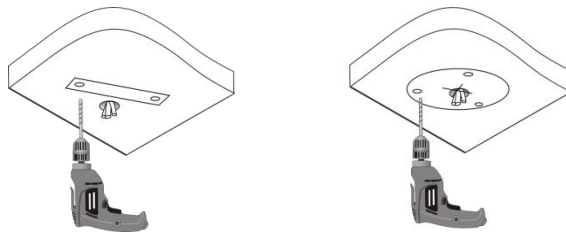

3. Mount the plastic rivets of self-tapping screws.

Knock the plastic rivets into the guide holes and ensure that they are tightened up.

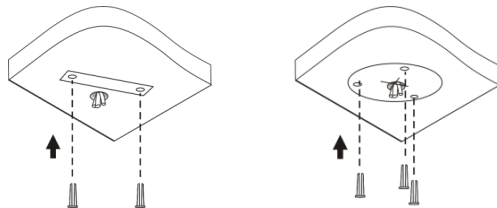

4. Mount the dome.

Connect all cables of the ceiling and the dome, lead self-tapping screws through the guide holes in the dome base, and then fix the dome on the ceiling by using a screwdriver.

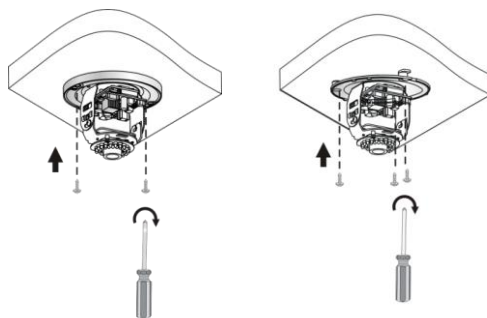

5. Adjust the monitoring direction of the lens (tighten screws after vertically adjusting the lens).

a. The lens can horizontally turn by rotating the lens base, as shown by ➊ in the following figure.

- b. After loosening the fastening screws, you can vertically turn the lens, as shown by ❷ in the following figure.

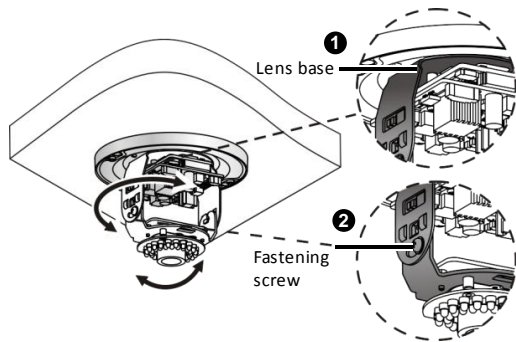

- 6. Attach the lining and lock it with the buckle on the base.

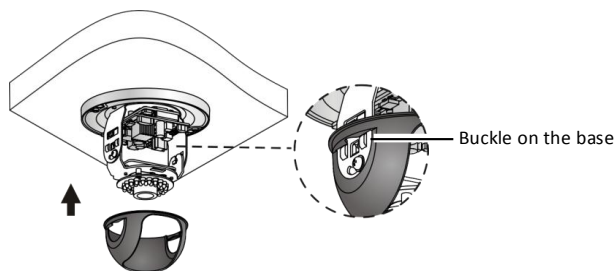

- 7. Mount the transparent dome housing.

- a. Align the screw holes in the base, and tighten the two cross-recessed pan-head screws on the edge of the transparent dome housing to fix it, as shown by ❶ in the following figure.
- b. Align the grooves (non-tail cable grooves) of the transparent dome housing to the buckle of the base, and push up the dome housing to fix it, as shown by ❷ in the following figure.

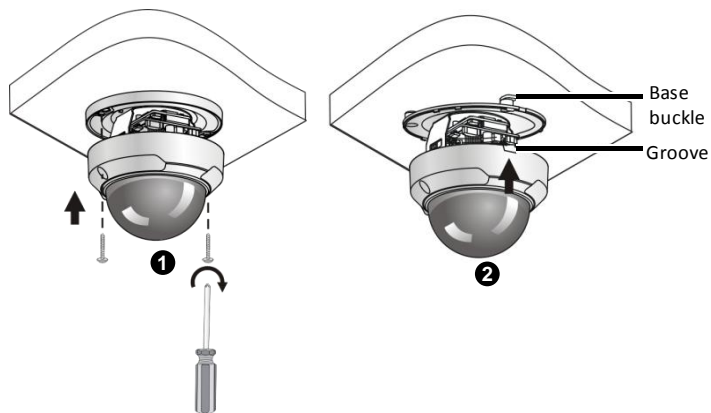

Metal fixed dome ceiling mount

- 1. Locate the positions of the holes.

Paste installation positioning stickers on the ceiling. Lead the cables across the hole on the wall.

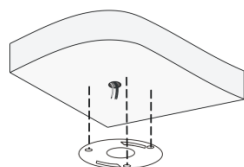

2. Drill holes on the wall.

Use a drill bit with a diameter of 6 mm or 6.5 mm to drill 30 mm-depth guide holes according to the positions marked by stickers.

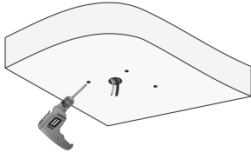

3. Mount the plastic rivets of self-tapping screws.

Knock the plastic rivets into the guide holes and ensure that they are tightened up.



4. Mount the ceiling bracket.

Lead self-tapping screws through the guide holes in the base and fix them on the ceiling by using a screwdriver.

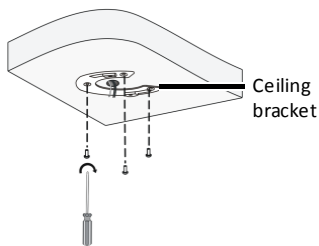

5. Connect all cables, and fix the dome and ceiling bracket.

- a.** Align the two buckles at the top of the dome to the opening holes of the ceiling bracket and push the dome upward.
- b.** Rotate the dome in the direction shown in the following figure and ensure that the dome is clamped by the ceiling bracket.

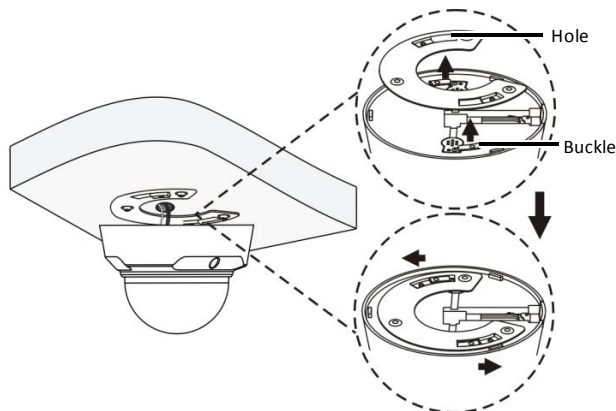

6. Remove the transparent dome housing and adjust the monitoring direction of the lens.
The lens can be rotated horizontally and vertically.

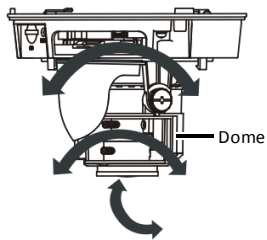

7. For a manual zoom lens camera, power on the device and adjust the manual zoom lens to get clear images.
 - a. Loosen the zooming and focusing knobs by using a flathead screwdriver and adjust the knobs to obtain clear images.
 - b. Then mount the dome housing to complete the mounting.

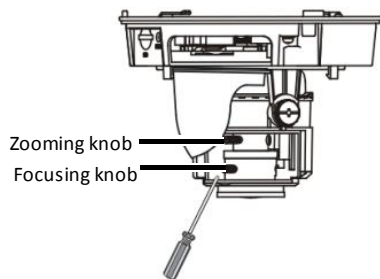

8. For a motorized zoom lens camera, it will automatically adjust the lens to present images.

Plastic fixed dome camera

1. Locate holes on the ceiling.

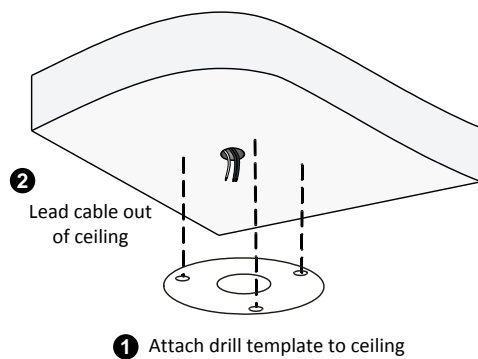

2. Drill holes according to drill template.

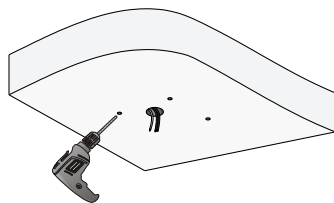

3. Knock in the plugs and make sure they are tightened in place.

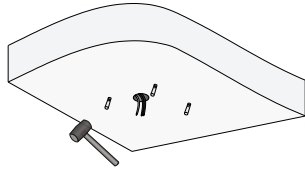

4. Remove the dome bubble.

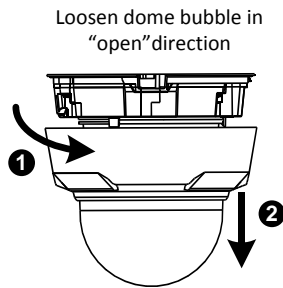

5. Mount the dome unit and connect the cables.

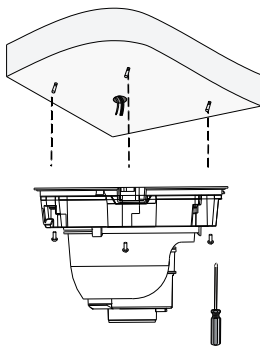

6. Adjust the monitoring direction.

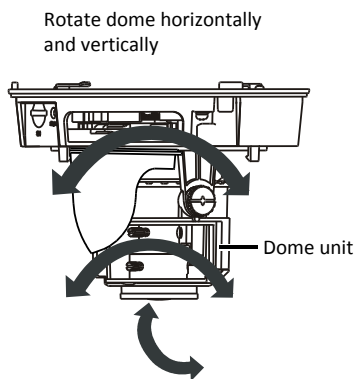

7. Connect the power. For a manual lens, adjust the lens until you get a satisfying image.

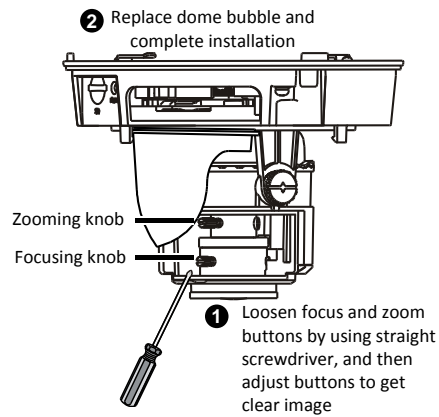

8. Connect the power. For a manual lens, adjust the lens until you get a satisfying image. For a motorized lens, adjust the lens through Web.

Mini dome camera ceiling mount

1. Locate holes on the ceiling.

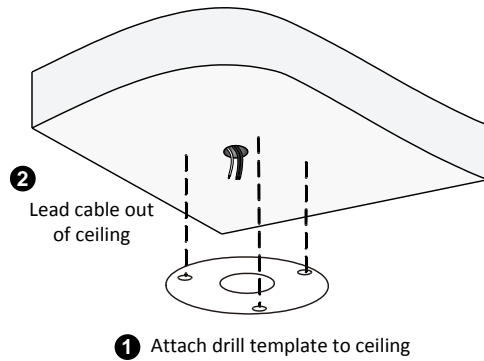

2. Drill holes according to the drill template.

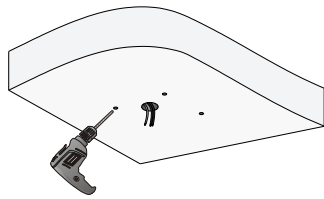

Use a drill bit (6 mm or 6.5 mm) to drill 30 mm-depth guide holes

3. Knock in the plastic plug.

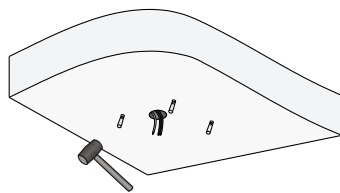

Make sure that plugs are tightened in place.

4. Remove the bottom ring.

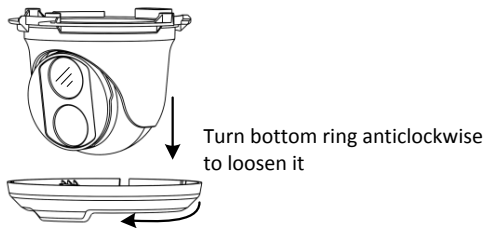

5. Connect the cable and then secure the dome.

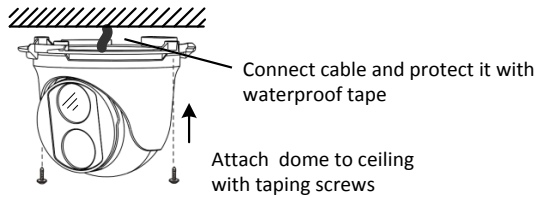

6. Adjust the monitoring direction.

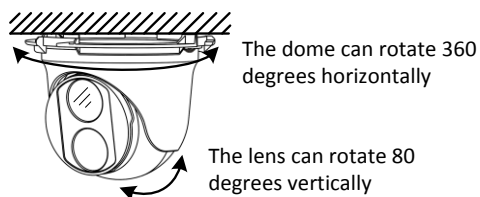

7. Mount the bottom ring.

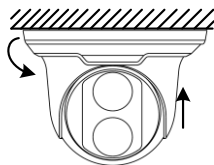

Push bottom ring back up and turn it clockwise to lock into position

8. The above steps are for concealed installation. For open installation, lead the cables out from the open slots and see [Mount the bottom ring](#) to finish the installation.

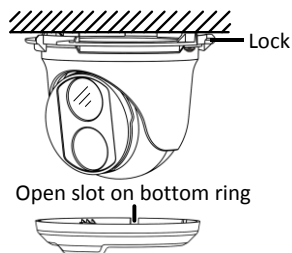

Parking lot detection camera

1. Slide and remove the bracket as shown in the figure.

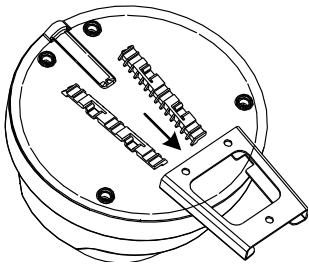

2. Mark the holes according to the bracket.

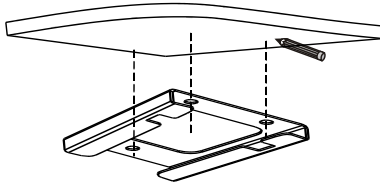

3. Drill holes on the wall

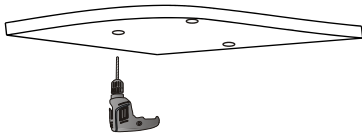

4. Attach the bracket to the wall.

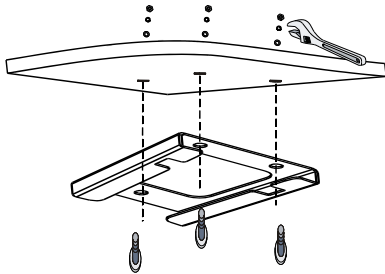

5. Secure the camera unit to the bracket.

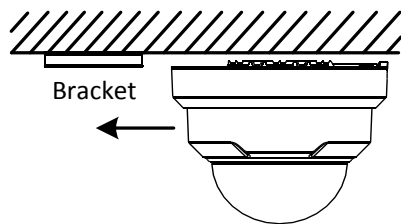

6. Turn and remove the housing on the camera unit.

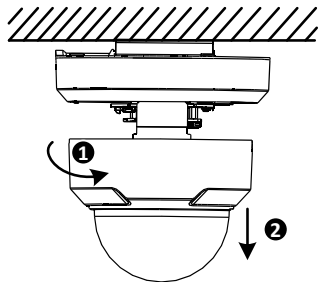

Adjust the monitoring direction. Unscrew the lens (as shown by ❶) to turn the lens vertically and horizontally (as shown by ❷ and ❸), and then tighten the lens.

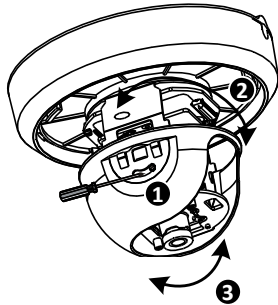

7. Replace the housing.

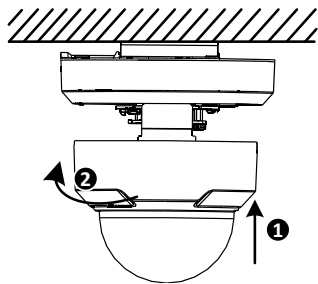

Waterproof Components for an RJ-45 Plug

1. Attach the seal ring to the copper interface.

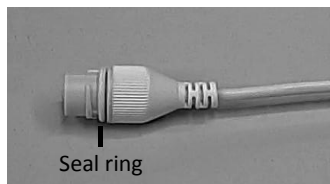

2. Mount the waterproof components.

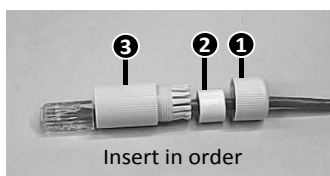

3. Insert the cylindrical waterproof ring into bolt.

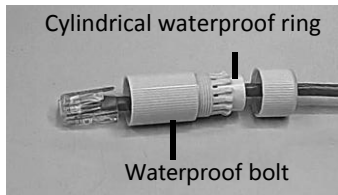

4. Insert the cable into the Ethernet copper interface and screw the waterproof bolt in.



5. Screw in the waterproof bolt lid.

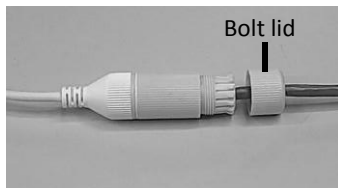

6. Finish the waterproof installation.

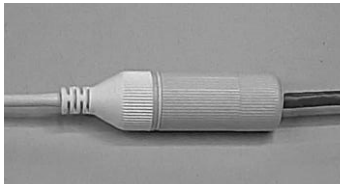

3 Cable Connection for External Device

Network cameras can be connected with external devices such as PTZ, audio/video devices and alarm devices.

This chapter introduces the features of various cables and wiring for them.

Cables and Adapters

Common Cables and Adapters

Table 3-1 Cables and Adapters







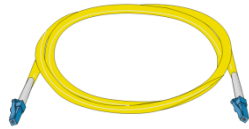



Figure	Name	Description	Mounting Requirements
	Composition video cables	Transmits analog video signal and connects to analog monitors	During installation, keep the cables away from interference source (like high frequency signal source, electric machine) and heat source. And avoid fully stretch and bend the cables at a sharp angle.
	3.5 mm audio cable	Transmits audio signal and connect to 3.5 mm audio input/output interface	During installation, keep the cables away from interference source.
	MIC cable	Connects to microphone	
	Power adapter	Output 12 VDC and 24 VAC	Place the adapter close to the device and do not lengthen the cable to the power mains. Do not route the cable for weak electricity in parallel with the cables for strong electricity.
	Power cable	Connects to power mains	During cable installation, choose the connector with PE terminal, and ensure that the PE terminal is connected properly. Note: Connect the power cable and the phoenix connector on the device correctly.

Figure	Name	Description	Mounting Requirements
	Network cable	Connects to Ethernet copper interface	During network cable installation, use the cable that compliances with 568B. And it is recommended that the length of one cable is less than 100 m. When making a network cable, crimp the inner wires to attach the connector properly.
	LC optical fiber connector	Connects to Ethernet optical interface (for SFP module)	-
	Grounding Cable	Ground the device to keep away the external interference.	Use the copper lug to ground the device and do not strip cable.
	CS Adapter	You can transfer a C type lens into a CS type lens by using a 5 mm CS adapter ring (for box cameras only).	Use CS adapter for the C lens. For CS lens, take care to tighten the lens to avoid damage IR-CUT components.
	4 Pin Z/F interface	Adjust the zoom and focus (For box cameras only).	For motorized lens, connect the control wires to the Z/F interface of the camera (using 4 Pin Z/F interface).

4 Pin Z/F Interface

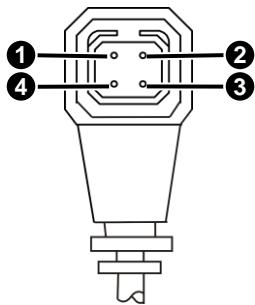

Table 3-2 Terminal Description

No.	Description	No.	Description
1	FOCUS +	2	FOCUS -
3	ZOOM +	4	ZOOM -

Wiring

- Keep strong-electricity cables (for example, power cord) at least 30 cm (11.81 in) away from weak-electricity cables (for example, network cable and audio/video cables).
- Connect the cables correctly. Wrong connection may damage the device. You can attach labels on the cables for easy identification to avoid wrong connection.
- Use the power adapter delivered with the product. Power adapter with poor quality may damage the device.
- Keep away with interference when installing alarm cables to avoid false alarm.
- Use T-shape connection when you connect RS-485 serial cables, that is, use one cable as a trunk, and distribute branches on the trunk. The cable on a trunk should be no more than 15 m (49.21 ft), and the terminating resistance is installed on the farthest camera. If multiple nodes are not in a straight line, use zigzag-shape connection. Do not use star shape or combination of T shape and zigzag shape.
- Do not lay video cables or RS-485 serial cables on stilts. Take lightning protection measures, for example, by using an external lightning protection device, when you lay video cables and RS-485 cables outdoors. For more information, see [Lightning Protection](#).

Cable Requirements

Video Cable

The commonly used composite video cables are coaxial cables. A coaxial cable consists of four layers. This cable has a copper center conductor surrounded by a foam polyethylene dielectric. A bonded copper braid provides shield coverage and the outermost polyethylene cover provides protection for the whole cable. The cable structure is shown in [Figure 3-1](#).

Figure 3-1 Coaxial cable

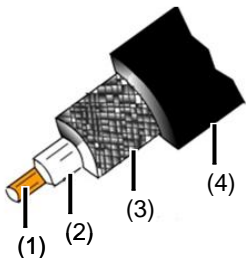
	(1) Center conductor
	(2) Polyethylene dielectric
	(3) Copper braid
	(4) Polyethylene cover

A larger section surface of the conductor provides less signal loss during transmission and a longer transmission distance. The shield coverage prevents the transferred signals from being interfered by external electromagnetic waves and electrostatic fields.

Coaxial cables include SYV-75-3, SYV-75-5, SYV-75-7, and SYV-75-9. The transmission distance of a cable depends on the ambient environment where the cable is used. Generally, in an environment with little electromagnetic interference and if the signal transmission attenuation is no more than

3dB, the transmission distance of SYV-75-5C is no more than 200 m (656.168 ft), and that of SYV-75-7C is no more than 300 m (984.252 ft). For more information about cable length that an encoder supports, see the actual specifications of the product.



NOTE!

Coaxial cables include SYV-75-3, SYV-75-5, SYV-75-7, and SYV-75-9. For example, one coaxial cable is named as SYV-75-5-1 (A/B/C). Of which S stands for radio frequency, Y stands for polyethylene insulation, V stands for polyvinyl chloride jacket, 75 stands for 75 Ohm, 5 stands for 5 mm, 1 stands for single chip, A stands for 64 braided, B for 96 braided, and C for 128 braided.

BNC interface is generally used to connect with video interface.

Figure 3-2 BNC Cable

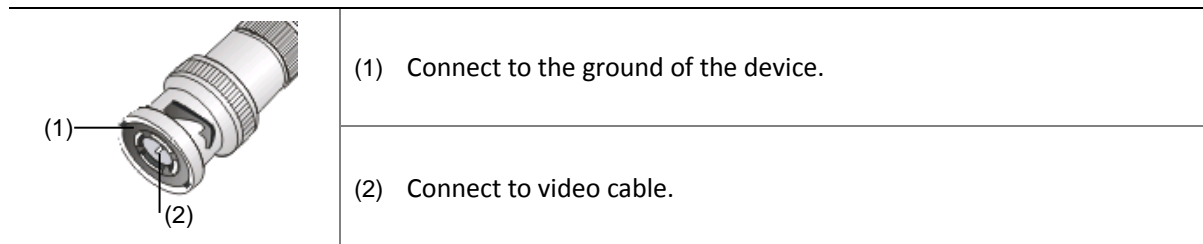

Audio Cable

Audio cables are usually made from 4-core shielded cable (PVVP) or unshielded digital communication cables. A larger section surface is required, for example, 0.5 mm². It is recommended that you use shielded audio cables and the maximum cable length is 100 m (328.08 ft.). Commonly used audio cables include RCA general audio cables and ordinary coaxial cables.

3.5 mm interface is usually used for audio interface.

Figure 3-3 Audio Interface Description

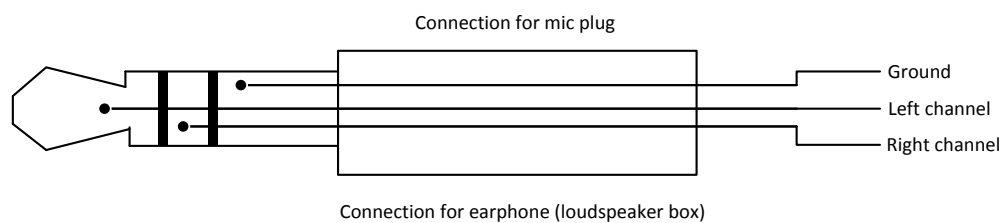

NOTE!

- You are recommended to use 3.5 mm single track MIC plug when connecting the camera and audio input device. Connect the device to the left audio, when you use the dual track MIC plug.
- You are recommended to use 3.5 mm dual track earphone or speaker when connecting the IP camera and audio output device.

Power Cable

Data listed in the table below is applicable to copper cables that use 24 VAC power supply. The item Core Diameter indicates the conductor diameter.

Table 3-3 Power Loss on the Cable for Different Length and Different Core Diameters (For reference only).

Distance (Unit: m) Power Consumption (Unit: W)	Core Diameter (Unit: mm)			
	0.80	1.00	1.25	2.00
30	28	45	72	183
40	21	34	54	137
50	17	27	43	110
60	14	22	36	91
70	12	19	31	78
80	10	17	27	68
90	9	15	24	61
100	8	13	21	55
110	7	12	19	49
120	7	11	17	45

Data listed in the table below is applicable to copper cables that use 12 VDC power supply. The item Core Diameter indicates the conductor diameter.

Table 3-4 Power Loss on the Cable for Different Length and Different Core Diameters (For reference only).

Distance (Unit: m) Power Consumption (Unit: W)	Core Diameter (Unit: mm)			
	0.80	1.00	1.25	2.00
30	14	22.5	36	91.5

40	10.5	17	27	68.5
50	8.5	13.5	21.5	55
60	7	11	18	45.5
70	6	9.5	15.5	39
80	5	8.5	13.5	34
90	4.5	7.5	12	30.5
100	4	6.5	10.5	27.5
110	3.5	6	9.5	24.5
120	3.5	5.5	8.5	22.5

RS-485 Serial Cable

It is recommended to use the following materials for RS-485 serial cables:

- UL-certified twisted pair cables that meet the standards of UL2464 and UL20276.
- Category-3 and higher cables that meet the overall cabling standards. The cable core can range from 22 to 28 American Wire Gauge (AWG). 24 AWG and 26 AWG are recommended.

The impedance of the cable should be in the range from 90 ohm to 150 ohm. The RS-485 port supports long distance communication; however, you must ensure that the overall cable attenuation is no more than 6 dB. For an encoder or a decoder, the total cable length should be no more than 900 m (2952.76 ft.), and the baud rate is recommended to be no more than 9600 bps. If a higher baud rate is required, choose the cable length according to the following table. If a too long cable is required, it is recommended to use repeaters to extend the transmission distance. A T-shape or Z-shape connection is preferred, or a star-shaped connection is adopted after an RS-485 hub is deployed at the device side.

Table 3-5 Maximum length of an RS-485 serial cable at different baud rates

Baud Rate (bps)	Maximum Length
1200, 2400, 4800, 9600, 19200	900 m (2952.76 ft.)
38400	850 m (2788.71 ft.)
57600	550 m (1804.46 ft.)
76800	400 m (1312.34 ft.)
115200	250 m (820.21 ft.)

Alarm Cable

Twisted pair cables are recommended. The cable should range from 22 AWG to 28 AWG (24 AWG and 26 AWG are recommended). The direct current (DC) impedance must not be more than 100 ohm. The following table shows the maximum length for different cables, taking 100 ohm as the maximum impedance.

Table 3-6 Maximum Length for Different Alarm Cables

Specifications (AWG)	Maximum Length (m)
22	1453 m (4767.06 ft)
24	914 m (2998.69 ft)
26	570 m (1870.08 ft)
28	360 m (1181.10 ft)

Network Cable

Network cables are mostly made from twisted pair cables, which are the most commonly used in cabling. Twisted pair cables includes unshielded twisted pair (UTP) cables and shielded twisted pair (STP) cables. An STP cable has a layer of bonded aluminum foil to reduce radiation. STP cables are more expensive than UTP cables, and STP cable installation is more difficult than UTP cable installation.

Optical fiber

The optical module in the camera should match that of the third-party device (such as a switch), in terms of fiber mode and emission/receiver wavelength. Ensure the transmission distance of the optical module is greater than the distance actually required.



NOTE!

For a dome camera with optical module, it should be connected to the single mode optical fiber instead of multimode optical fiber.

Ensure that the following requirements are satisfied when connecting two devices using an optical fiber:

- When an SFP optical module is connected, the curvature of the optical fiber should be greater than 90 degrees.

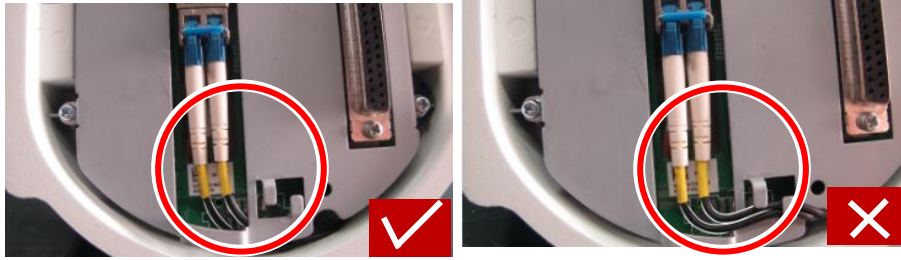

- When mounting the tail cable unit, ensure that the optical fiber is not clamped by the device. Otherwise, the optical fiber could be damaged.
- Avoid excessively bending the optical fiber during mounting. If the optical fiber is too long, coil the optical fiber. Ensure that the coil diameter is greater than 60 mm and the curvature is greater than 90 degrees.

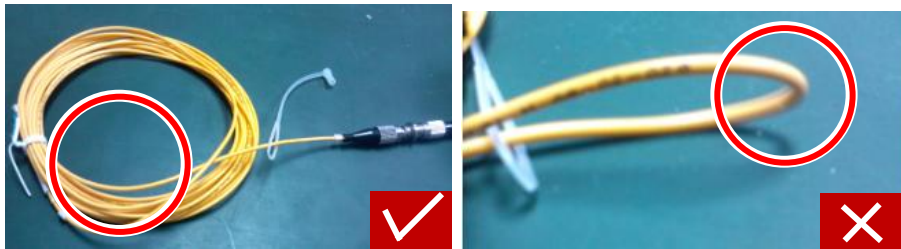

- Select a high-quality fiber connector. If a non-standard fiber connector without chamfering is used, internal ceramic sleeves such as the optical module, flange, or optical splitter could be damaged.
- Ensure that the fiber connector is in good condition, the latch is not disrupted and keeps elasticity, and the connection to the peer end is normal.

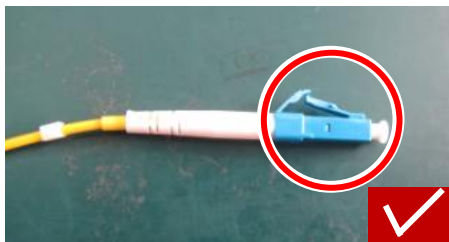

- Before connecting an optical fiber, check that there is no obvious surface defect such as stain, scratch, dent, or pit. If the fiber connector, flange, or optical module is dirty, clean it with alcohol and clean cotton (or a clean cotton rod).
- When using an optical fiber to connect the device, if a flange is required for connecting the fiber connector, determine the model of the flange according to the type of the fiber connector on the peer device at first, or perform cascading by directly using an optical splitter.
- When using a fiber connector to interconnect with a flange, aim the fiber connector at the slot of the flange so as to ensure proper interconnection.

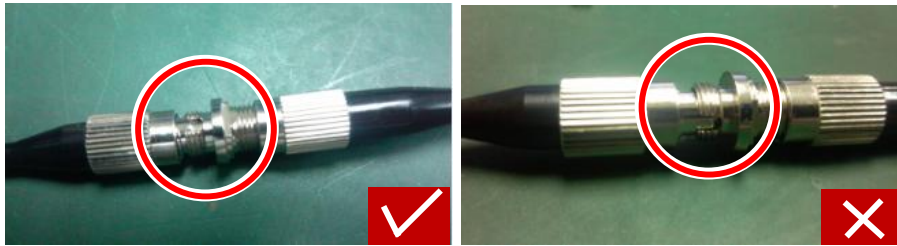

Ground Wire

The ground wire should be no longer than 30 meters (98.43 ft.), and its impedance must be less than 5 ohm. For more information, see the YD5098 standard.

Cable Connection

Connecting to PTZ Cameras through an RS-485 Port in PTZ Control Mode

The wiring for other cameras are similar, the following takes box camera as an example.

When using an RJ-45 connector, you can connect the RJ-45 connector to the PTZ control cable as follows:

- Connect T+ of the RJ-45 connector to A (RS485+) of the PTZ control cable; and connect T- of the RJ-45 connector to B (RS485-) of the PTZ control cable, as shown in [Figure 3-4](#).
- If the PTZ camera uses a ground wire, connect the ground pin of the PTZ control cable to the ground pin (pin 7 or 8) of the RJ-45 connector.

Figure 3-4 Wiring (For Box Camera)

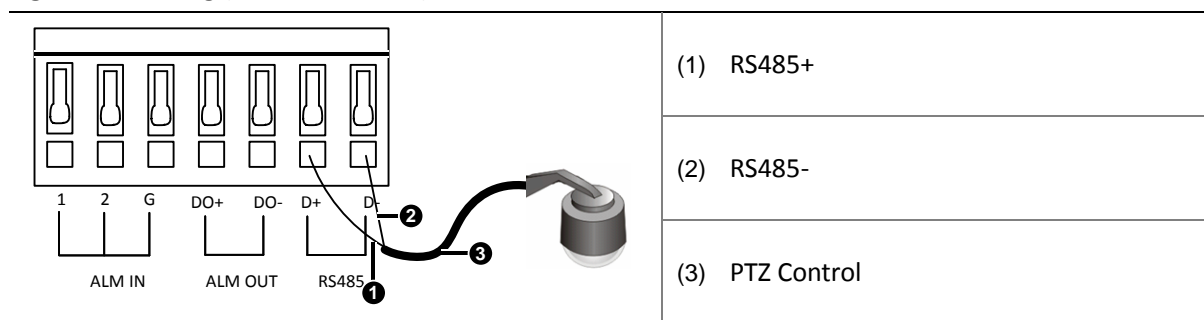

Table 3-7 Phoenix Connector Description

Pin	Description	Pin	Description
+	RS485+	-	RS485-
G	Ground		

Connecting to a Third-Party Device through an RS-485 Port in Transparent Channel Mode

The wiring for other cameras are similar, the following takes box camera as an example.

- When using an RS-485 cable with an RJ-45 connector to connect to a third-party device, you can connect the RJ-45 connector to the third-party device cable as follows:
- Twist T+ and R+ of the RJ-45 connector and connect them to the RS485+ of the third party device cable. Twist T- and R- of the RJ-45 connector and connect them to RS485- of the third party device cable, as shown in [Figure 3-5](#).
- If the third party device uses a ground wire, connect the ground pin of the third-party device cable to the ground pin (pin 7 or 8) of the RJ-45 connector.

Figure 3-5 Wiring (for box camera)

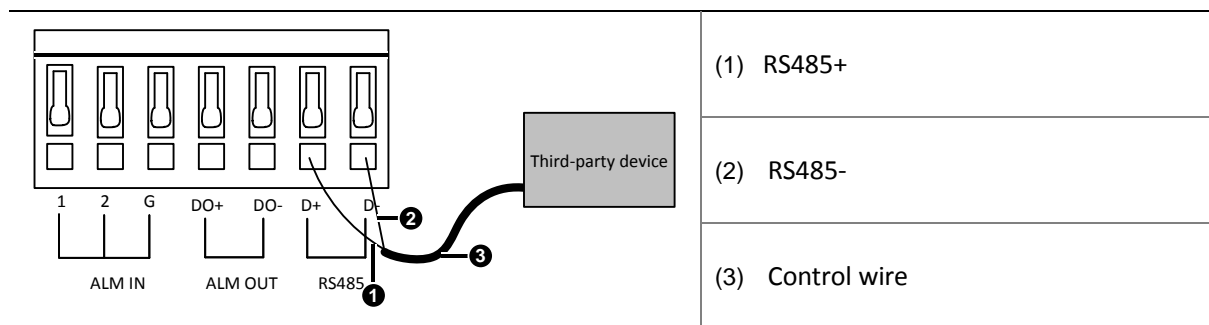

Connecting to Alarm Input/Output Device

Alarm Input Connection

Figure 3-6 Wiring

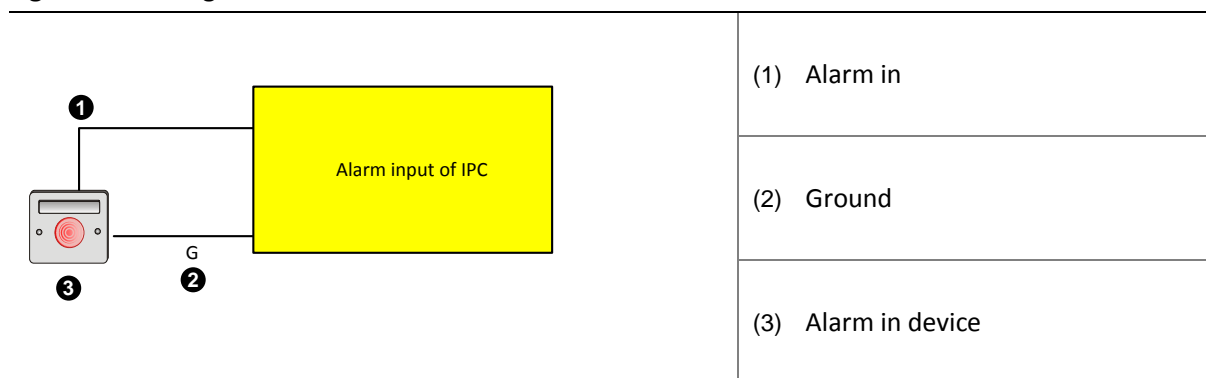

Alarm Output Connection

Figure 3-7 Wiring (for a DC load)

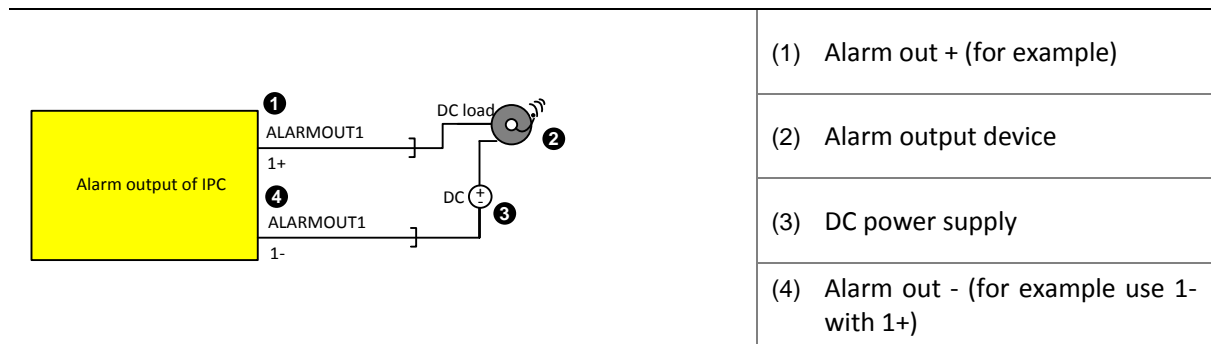
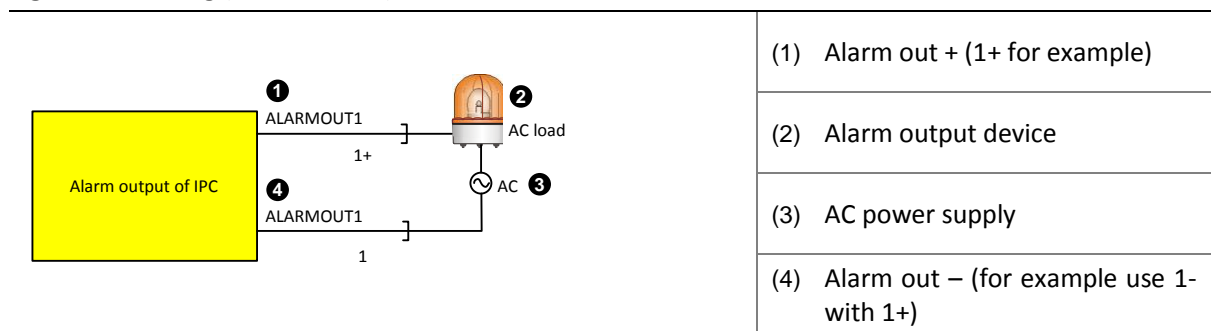

Figure 3-8 Wiring (for a AC load)



NOTE!

When using the external power supply for the alarm output device, ensure that their rating values (output voltage and current) meet the requirements. Upper limit of the external power supply: 30 VDC, 1A or 125 VAC, 0.3A.

4 Lightning Protection and Grounding

IP cameras are generally installed outdoors, which is why lightning protection is of great importance. When the camera is installed in extreme environment, you should take related lightning protection measures. This chapter introduces how to perform lightning protection measures for a camera mounted outdoors by installing a protection box, grounding the device properly.

Outdoor Protection Box

Equip a protection box for the camera mounted outside to protect the camera from rain, dust, high temperature, vibration and corrosive substance.

If there is no protection box supplied, you can put the camera into a protection box.

The requirements are as follows:

- Protection box can be metal or plastic, the metal ones are more protective than plastic ones.
- Use the protection box ranked IP66 (or higher) to keep away from water or dust.
- Do not the stack devices in one protection box and make sure that leave about 5cm space around camera for heat dissipation.
- Use a grounding connector to connect all the grounding cables properly.
- Use protection boxes with temperature regulators (inner heater or fan) in extreme environment.
- Attach the lens to the window on the protection box closely when installing the box to keep the reflected light from entering the lens.

Lightning Protection

Lightning protection measures are shown as follows:

- Place the camera in the protection area of discharging rod, see [External Protection](#) for more information.
- Data shows that more than 80% lightning problems in monitoring system are caused by the over voltage induced by the lightning. Lightning protection for cable plays an imperative role in the system protection. See [Cable Protection](#) for more information about cable protection.
- Install proper arrestors in the device to prevent the lightning from attacking the device. For example, you need to install arrestors for power cable, video cable and control cable. See [Inner Protection](#) for more information.

External Protection

Install the discharging rod to protect the device from lightning.

Cameras must be installed in the protection area of the discharging rod, for example, you can place the discharging rod 3 or 4 meters away from the camera.

Cable Protection

Route the cables carefully to protect them.

It is recommended to bury the cables with metal pipes covered, and ground the metal pipe properly.

Or you can use following method:

- Use the metal pipes to cover the cables and route the pipes above the ground.
- For the cables connected directly with the cameras and equipment room, bury the cables with metal pipes covered. The cables buried need to be more than 15 m and the metal pipe must be grounded properly. And install arrester at the two end of the each cable.

Inner Protection

Choose an arrester according to its regular value (maximum operating voltage, insert loss, data transmission rate and so on).

Requirements for Signal Arrester

1. The connection for the arrester conforms to equipotential principle. There is a joint point for grounding cables connection between arrester and device. The cable between arrester and joint point must be shorter than the recommended value by the arrester. If the arrester does not provide a recommended length, you can use the cables between 0.3 m and 0.5 m, and use the grounding cable as short as possible.

Figure 4-1 Mounting Description

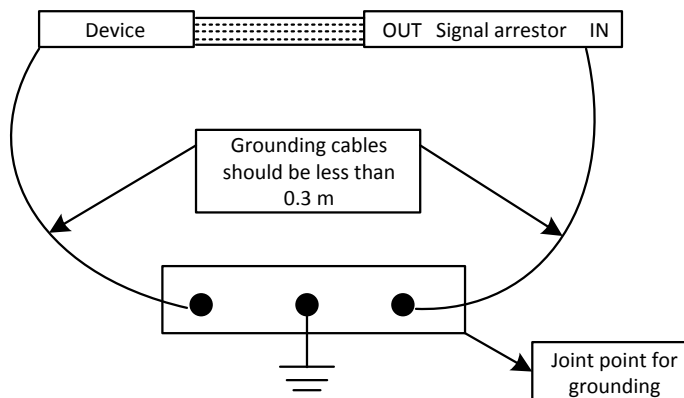

2. When the length of the cable between the arrester and joint point does not meet the connection requirements, you need to connect the device and arrester as shown in the [Figure 4-2](#).

Figure 4-2 Equipotential Connection

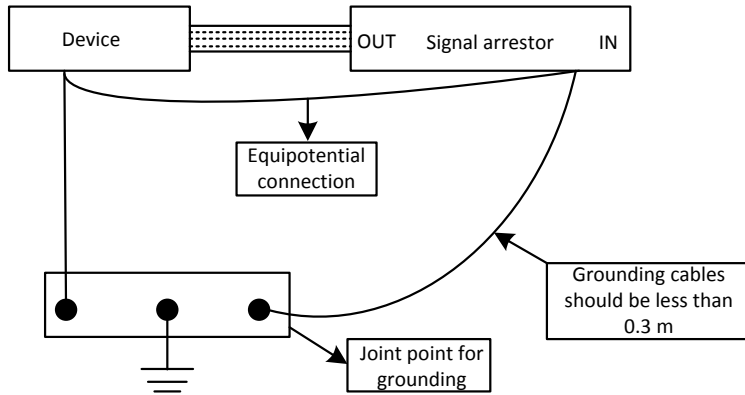

NOTE!

Please follow the steps above to install the arrestors and connect devices according to the field conditions.

3. Connect the arrester and the device as shown in the [Figure 4-3](#). Connect the IN terminal with signal channel and OUT terminal with the device.

Figure 4-3 Connection for Arrester

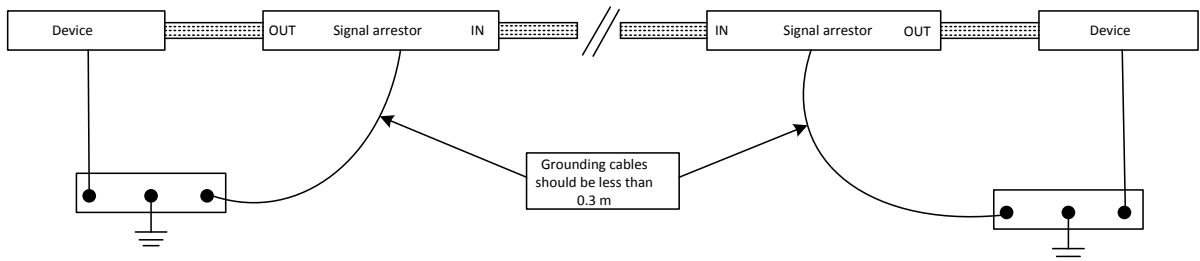

Requirements for Power Arrester

- Make sure that the cables for power arrester as short and thick as possible.
- Make sure that the cross sectional area larger than 25 mm².
- Increase the cross section area when the cable is longer than 1 m.
- Cables should be routed compactly or tied together.
- The grounding cable on the power arrester is combined by many copper wires with its cross sectional area 25 mm² to 35 mm².

Installing Arrester

Follow the steps below:

1. Place the arrester close to the device.
2. Adjust the grounding cable length on the arrester according to the distance between the device and arrester.

3. Make sure that the grounding cable on the arrester and the device chassis are connected properly.
4. Connect the IN terminal on the arrester to external signal cables, and the OUT terminal to device protected. Make sure the indicators are shown correctly.
5. Tie the cables with nylon clips.



CAUTION!

See the specifications of the arrestors for detailed information.

Ground a Device

For outdoor or indoor cameras, you must ground the device properly. Choose a proper grounding method.

Grounding a device with DC power supply

The same grounding method is used for devices which adopt DC power supplies.

Using grounding bar

When the equipment room has a grounding bar, you can connect one end of the ground wire of the device to the cable post of the grounding bar and fasten them with screws, as shown in the following figure.

Figure 4-4 Ground the device through a grounding bar

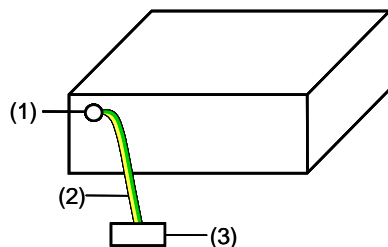

1: Grounding screw	2: Ground wire	3: Grounding bar
--------------------	----------------	------------------

Connect the ground wire of the device to the protection ground in the equipment room. Do not ground the chassis to a fire hydrant, radiator, or lightning arrester.

Using buried object

If there is no grounding bar but an earth ground available for burying an object, you can bury an angle iron (or steel pipe) no less than 0.5 m (1.64 ft.) to the earth for grounding. Then, connect the ground wire of the device to the angle iron (or steel pipe) by welding, as shown in the following figure. The welding point should be treated against corrosion.

Figure 4-5 Ground the device through a buried object

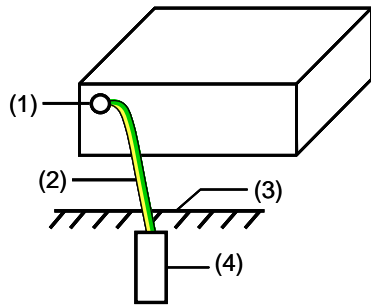

1: Grounding screw	2: Ground wire	3: Earth	4: Angle iron (or steel pipe)
--------------------	----------------	----------	-------------------------------

Grounding a Device with AC Power Supply

Using grounding bar

When the equipment room has a grounding bar, you can connect one end of the ground wire of the device to the cable post of the grounding bar and fasten them with screws, as shown in the following figure.

Figure 4-6 Ground the device through a grounding bar

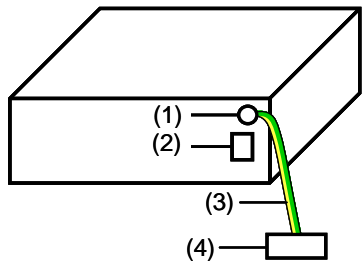

1: Grounding screw	2: AC power input	3: Ground wire	4: Grounding bar
--------------------	-------------------	----------------	------------------

Connect the ground wire of the chassis to the protection ground in the equipment room. Do not ground the chassis to a fire hydrant, radiator, or lightning arrester.

Using buried object

If there is no grounding bar but an earth ground available for burying an object, you can bury an angle iron (or steel pipe) no less than 0.5 m (1.64 ft.) to the earth for grounding. Then, connect the ground wire of the device to the angle iron (or steel pipe) by welding, as shown in [Figure 4-7](#). The welding point should be treated against corrosion.

Figure 4-7 Ground the device by burying an object to the earth

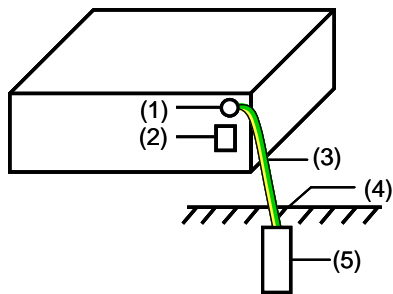

1: Grounding screw	2: AC power input	3: Ground wire	4: Earth
5: Angle iron (or steel pipe)			

Using protective earthing conductor of AC power cable

If the device installation environment does not have a grounding bar, and does not allow burying a grounding object, you can ground the device by connecting it to the PE conductor of the AC power cable, as shown in [Figure 4-8](#). Meanwhile, make sure the PE conductor is properly grounded in the power distribution room or at the AC transformer side.

Figure 4-8 Ground the device through a PE conductor

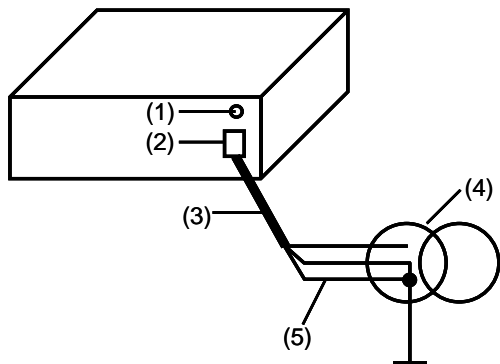

1: Grounding screw	2: AC power input	3: AC power cable
4: Power transformer	5: PE conductor	

5 Waterproof Measure

After you connect the tail cables, you must use the waterproof tape to protect the tail cables. The following figures are for your reference only.



CAUTION!

- Prevent the cables from being shorted when covering the insulated rubber tape.
 - Tie the waterproof tape tightly and cover all the cables.
-

1. Connect the cables.

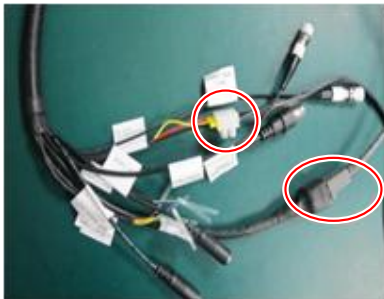

2. Use insulated rubber tape to protect the connect point.



3. Choose a proper start point to cover the waterproof tape.



4. Tie the cables together with insulated rubber tape.



5. Choose a proper start point to cover the waterproof tape.



6. Protect the cables with waterproof tape.



6 Solutions for Common Problem

How to Adjust Back Focus

For manual lens, if you cannot get clear image after turning the lens, you can adjust the back focus.

For motorized lens with ABF (automatic back focus), you can adjust the back focus by referring to the lens specifications.

For motorized zoom lens without ABF function, adjust the back focus by using the BF knob. You can follow the steps below.

To install the camera in a protective box, leave rooms surrounding the lens for your easy adjustment of zoom and focus.



NOTE!

Some models of box camera support ABF function (automatic back focus). You can press the **ABF** button on the rear panel of the camera or log in to the Web to adjust the back focus.

1. Open the iris to the maximum, and then direct the camera to an object (such as a test card with high contrast) about 3 meters away.
2. Loosen the back focus knob.

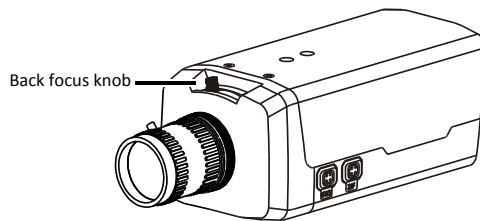

3. Adjust the focus of lens to the minimum, and then fine tune the back focus knob to get clear image.
4. Adjust the focus of the lens to the maximum, and then fine tune back focus knob to get clear image.
5. Repeat the step 3 to 4 until you can always see clear image when changing the focus of the lens.
6. Tighten the back focus knob.

System does not Prompt You to Install ActiveX for Your First Login on Windows 7

Enter **User Account** under **Control Panel**, click **User Account** and select **Change User Account Control Setting**. Move the slider to **Never Notify** and log in to the system again.

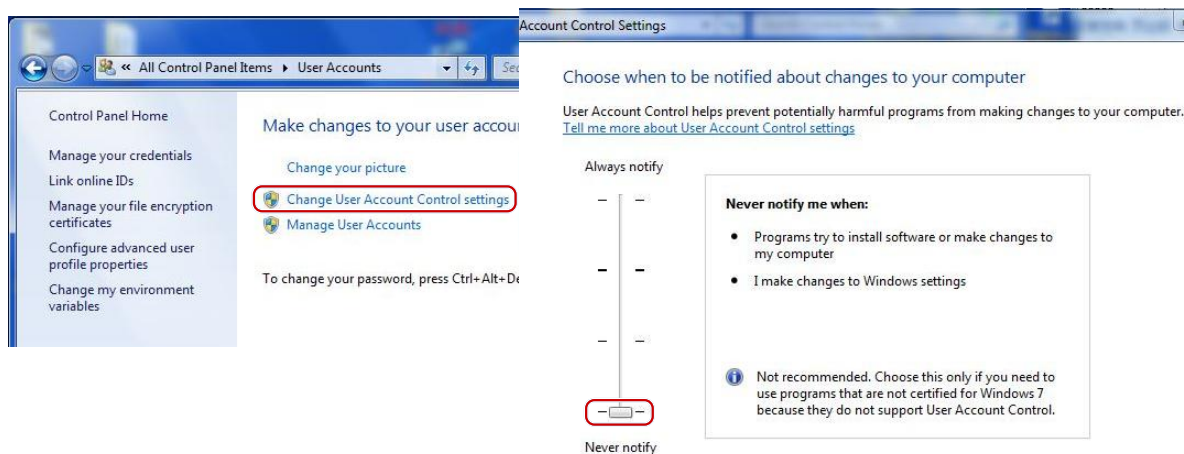

Fail to Install ActiveX

Before login, open **Internet Option** in IE, and click the **Safety** tab. Choose **Trusted Site**, and click **Site** to add the website.

If you use the Windows 7, you need to save the ActiveX to your PC first. Right-click the setup file, select **Run as administrator**, and then install it according to instructions.

You Cannot View Live Video After Your First Login.

Close the firewall on your PC, and then log in to the device again.