

2 WIRE HOME Wi-Fi SYSTEM

DX471-TD7

7" COLOR TFT Wi-Fi MONITOR



- Please read this manual carefully before using the product you purchase, and keep it well for future use.
- Please note that images and sketch maps in this manual may be different from the actual product.

Contents

1.Parts and Functions	1
2.Mounting	2
3.Main Menu	3
4. Answering a Call	5
5.Panview & Zoom	6
6.Monitoring	6
7.Call Another Room or Apartment(Intercom)	8
8.View Call Record.....	10
9.Open Staircase Light.....	11
10.No Disturb Function	12
11.Divert Call.....	13
12.Setting	14
Enter setting interface.....	14
Ring tone setting	15
General setting.....	15
Installer setting.....	19
Wireless setting.....	24
About.....	29
13.Download Setup 2Easy APP.....	30
14.Surveillance door station via 2Easy APP	32
15.How It Works.....	32
16.Specification.....	34
17.Precautions	34

1. Parts and Functions

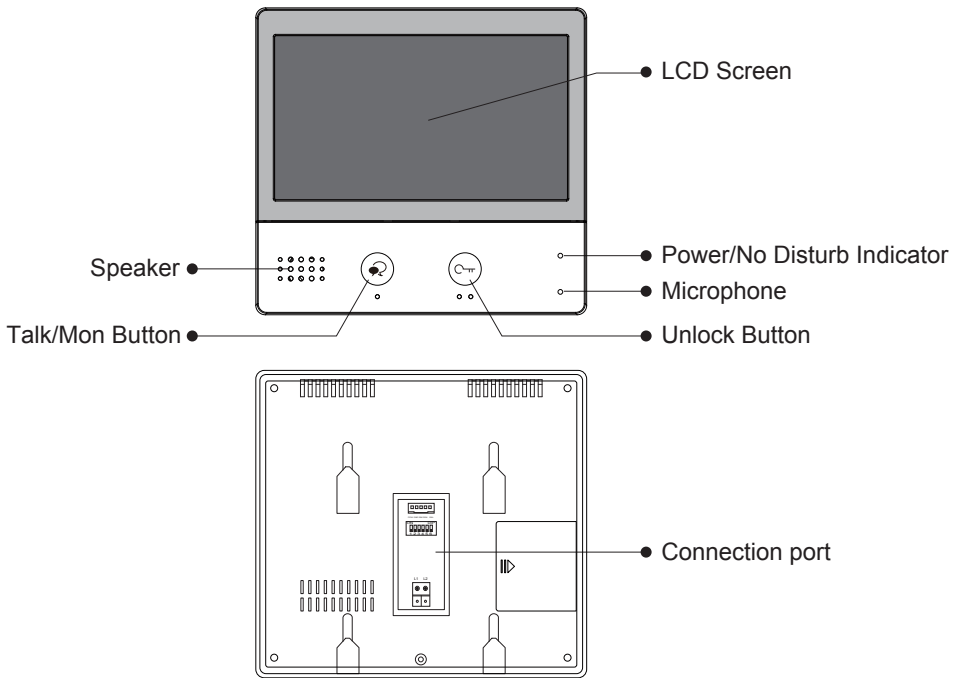

Key functions

Speaker	Send out voice from the visitor.
Talk/Mon button	Press to communicate hands free with visitor; Press to view the outdoor condition in standby mode.
LCD screen	Display the visitors' image.
Power/No Disturb indicator	Show the power status of the system. Show the no disturb status.
Microphone	Transmit audio from one station to other stations.
Unlock button	Press to release the door.
Connection port	Bus terminal, Setting the monitor's address.

Terminal description

SW+,SW-: Extra door bell call button connection port.

Ring,GND: Extra buzzer connection port.

POW,GND: 12~16V extra power connection port.

DIP switches: Total 6 bits can be configured.

- **Bit1~Bit5:** User Code setting switch.
- **Bit6:** Video impedance matching switch.

L1,L2: Bus line terminal.

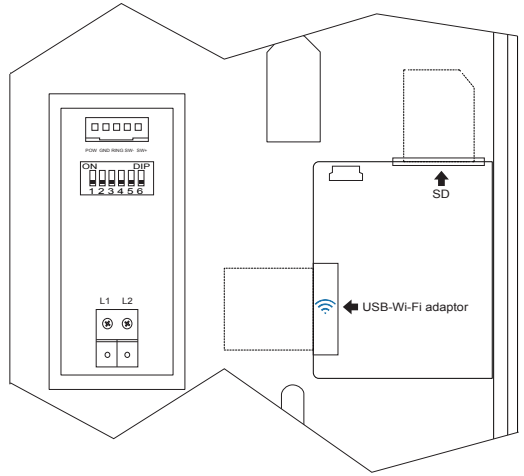

2. Mounting

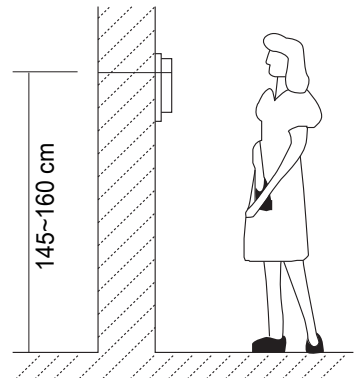
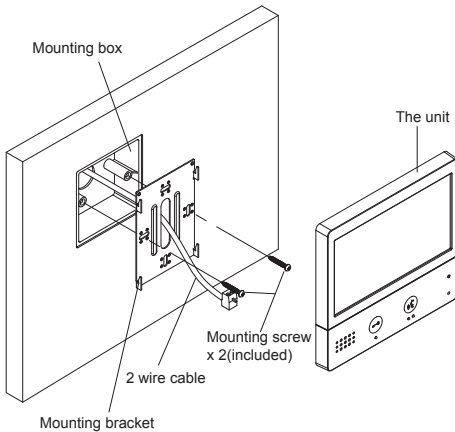

The installation height is suggested to 145~160cm.

1. Use screws to fasten the mounting bracket to the wall with mounting box.
2. Connect the 2 wire cables to the unit.
3. Mount the unit to the mounting bracket, make sure the unit is absolutely attached to the mounting bracket.

3. Main Menu

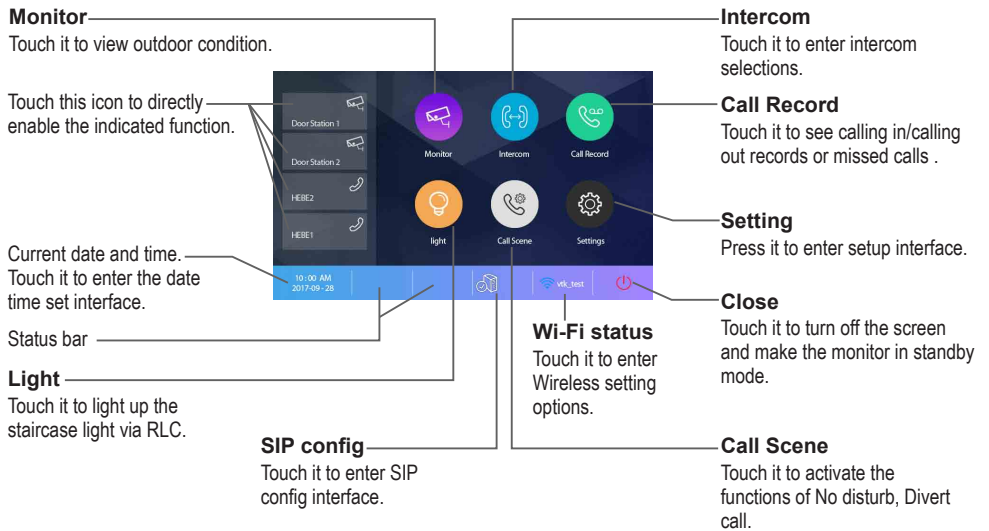

The Main menu is your starting point for using all the applications on your monitor.

Touch **Unlock** button, or touch anywhere of the screen on monitor in standby mode, the Main menu will appear as follow:



Function status

Icon	Meaning	Description
	Missed call	Display when there is missed call unread. Touch it to review the missed call in shortcut.
	No disturb	Display when activate the function
	Call transfer	Touch it to enter Call Scene interface in shortcut.
	SIP server connection active and configured	Touch it to enter SIP server information interface in shortcut.
	SIP server connection disabled	
	SIP server connection active and not connected	

Icon	Meaning	Description
	Wi-Fi connection active and not connected	Touch it to enter Wi-Fi setting interface in shortcut.
	Wi-Fi connection disabled	
	Wi-Fi connection active and configured	

While talking with a door station

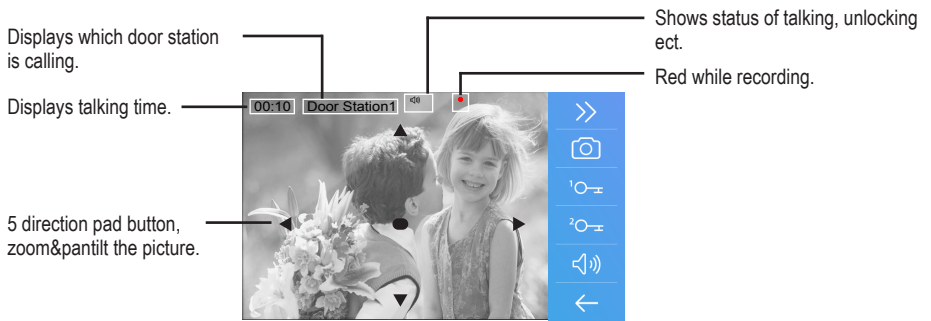

Note: The 5 direction pad operation should make effective with **fish-eye** door station.

4. Answering a Call

1. Touch it to answer the call.
To end the call touch it again.

2. If necessary, during the call touch it to display the audio/video adjustment icons.

3. Touch it to record image/video.

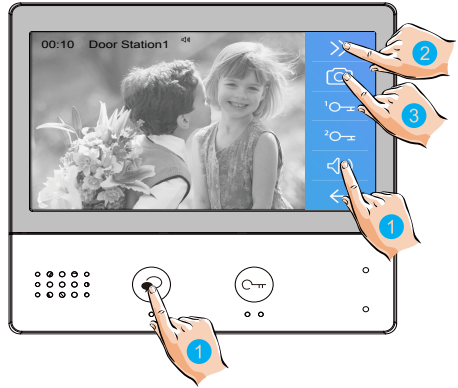

4. Touch the icons to adjust the parameters you want.

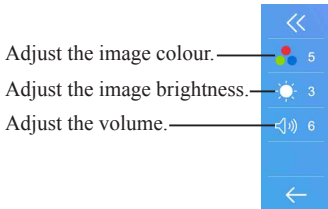

5. Touch it to open the door lock for visitor.

The door lock key display on screen briefly, to indicate that the door lock has been released.

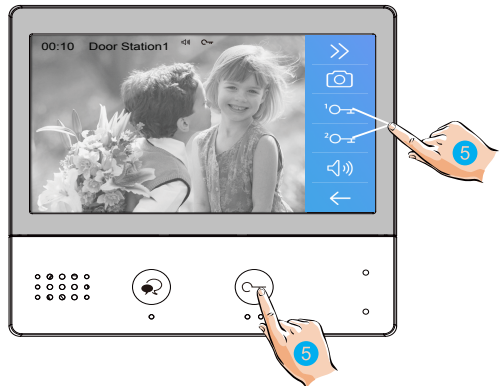

5. Panview & Zoom

If wants to see greater detail about visitors,move to the desired position by touching ▲ ▼ ● ◀ ▶ on the screen to view the image in pantilt & zoom mode.

1. Touch it to activate the panview and zoom function.

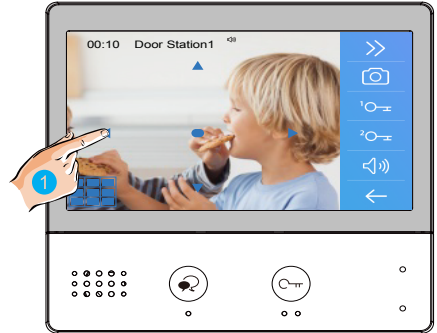

6. Monitoring

This section can be used to monitor your home by enabling one of the cameras inside the apartment, the common areas (e.g. garages, garden), and at the entrance.

1. Touch it to display the cameras in your system.



2. Touch it to activate the desired camera on Monitor interface.

3. It is possible to “>” (display in sequence) the other cameras.

4. Touch it to return the previous menu.

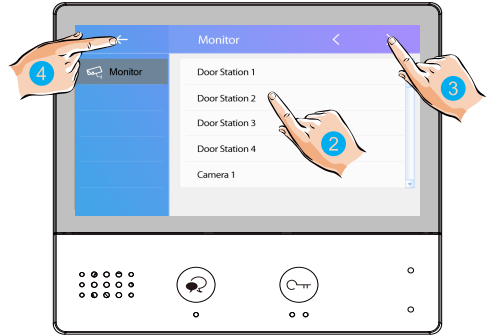

5. Touch it to activate the specified camera in shortcut.



The display shows the images recorded by the active camera.

6. If the camera belongs to an Door Station, touch it to activate audio communication.

Touch it again to return the Monitor interface.



7. Call Another Room or Apartment (Intercom)

It is possible to communicate with another device installed in another room of the apartment or with a device of another apartment.

1. Touch it to display the available intercoms.
2. Touch it to display the available namelist calls.
3. Touch it to activate the communication with the desired intercom.

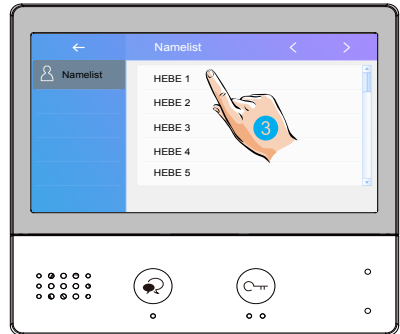
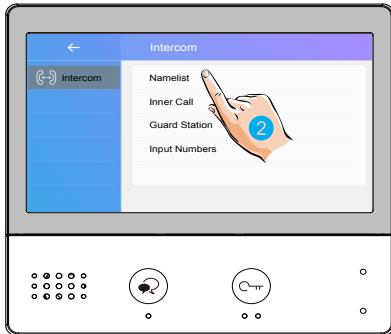

the call is active.

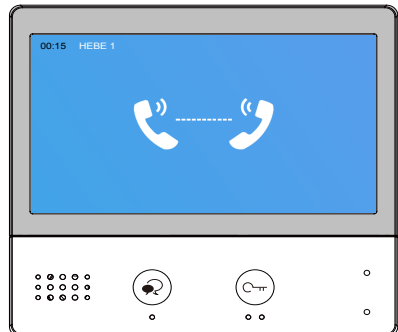

4. Touch it to activate the communication with another room.

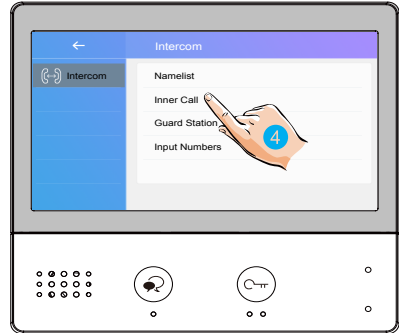

5. Touch it to activate the communication with guard station.

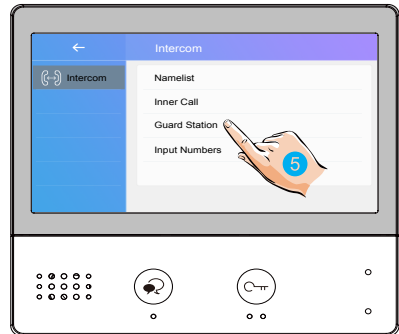

6. If the system does not have the room number you want, you can enter other room number. Touch it to enter input numbers interface.

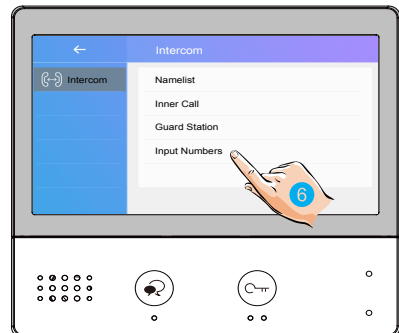

7. Input the room numbers you want.

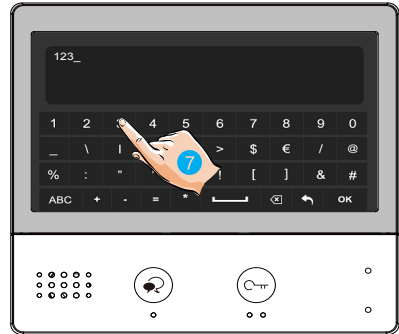

Note: when a call is received from the Door Station while the internal unit is in “intercom” mode, the system follows the priority rules and ends the active call.

8. View Call Record

When there are one or more unread call records in the answering machine, clicking the icon shows them.



1. Touch it to enter call record interface and display the records. These records include missed calls, incoming calls, outgoing calls and playback.

2. Touch it to show the missed calls.

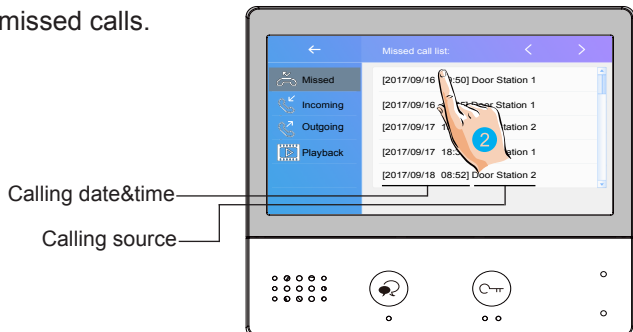

The informations you select is played back automatically.

3. Touch it to scroll interface.

4. Touch it to delete the image.



9. Opening Staircase Light

Note: The staircase light should be connected on the system, and this function should be supported by RLC. Please refer to RLC user instruction in detail.

1. Touch it to open the staircase light.

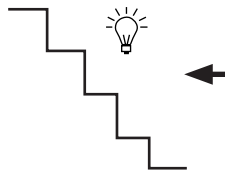

10. No Disturb Function

If you don't want to be disturbed, for example, at night. Activating the mute function is necessary for you.

1. Touch it to enter call scene interface.



2. Touch it to set the no disturb mode: No Disturb 8H and No Disturb Always.

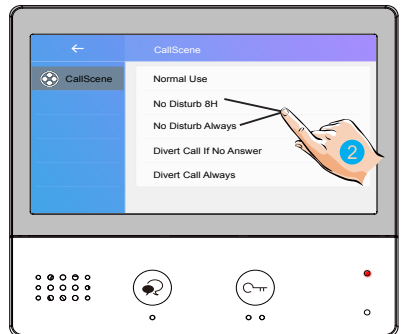

No Disturb 8H: The calling from door station or other monitors will be forbidden for 8 hours.

No Disturb Always: The calling from door station or other monitors will be forbidden all the time until the function is released.

Note:

* The no disturb indicator turns from green to red, to indicate that the no disturb function has been activated.

* This function will perform immediately if selected, and the status bar on main menu interface will show "🔕" icon.

11. Divert Call

The calling from door station can be diverted to your phone. please note that this function should be supported by Wi-Fi or SIP network.

1. Touch it to enter call scene interface.



2. Touch it to set the divert call mode:
Divert Call If No Answer and Divert Call Always.

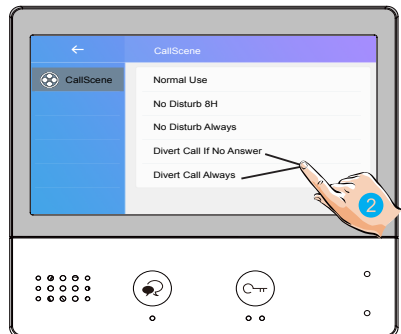

Divert Call If No Answer: If nobody answers the call in 30s when receives call from door station, diverts the call to the smart phone.

At this mode, the monitor will always open the screen and show image from door station during diverted, if the monitor answers the call at this time, diverted will conclude at once.

Divert Call Always: When receives call from door station, diverts the call to smart phone directly.

At this mode, the monitor will shut off the screen after diverting successfully, but you can still use it in normal.

Note:

* If divert the call to smart phone via Sip sever, need to choose one.

* This function will perform immediately if selected, and the status bar on main menu interface will show "📶" icon.

12. Setting

Enter setting interface

1. Touch it to enter setting interface.

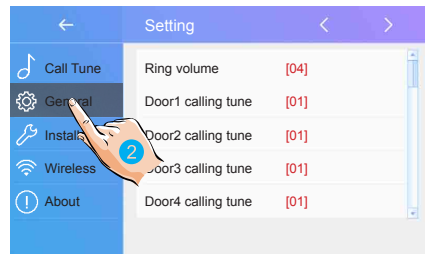

2. Touch the icon for the desired customisation, choosing among:

Call Tune >	Ring volume -Door1 calling tune -Door2 calling tune -Door3 calling tune -Door4 calling tune -Doorbell calling tune -Intercom calling tune -InnerCall calling tune -GuardCall calling tune
General >	Date and time -Language -Monitor time -Shortcut setting -SD card -Restore to default
Installer >	Current address -Intercom enable -FW upgrade -System setting
Wireless >	Wi-Fi switch -Wlan setting -Wireless device regist -IP/Smart phone regist -SIP config
About >	All kinds of device information

Ring tone setting

The ring call tone can be set individually to distinguish different calling sources. Total 22 tones can be selected.

1. Touch it to enter call tune setting interface.
2. Touch the setting item to select the call tone.

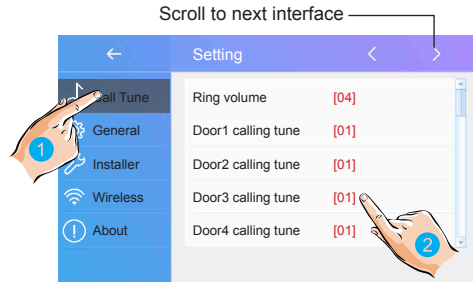

Ring volume: adjust the ringtone volume.

Door1/2/3/4 calling tune: call tone from door1/2/3/4 entrance panel.

DoorBell calling tune: call tone from doorbell.

Intercom calling tune: call tone from an intercom of another apartment.

InnerCall calling tune: call tone from an intercom in your apartment.

GuardCall calling tune: call tone from the Gurad unit.

General setting

This section contains the general settings and device information.

1. Touch it to enter general setting interface.

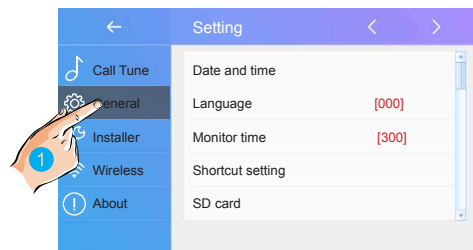

Date and time setting

The current date and time can be modified at any time.



1. Touch it to enter the date time set interface.
2. Touch it to select the item you want to change.

Date mode: 2 display mode: month/date/year and date/month/year

Time mode: 2 display mode: HOUR_12 and HOUR_24.

Date: touch it to set the date .

Time: touch it to set the time.

Time zone: touch it to set the time zone in your country.

Time auto update: **Disable:** should set the time manually. **Enable:** can synchronize the system time

Changing the display language

The default language can be customized. But you can change it to your desire language at any time.

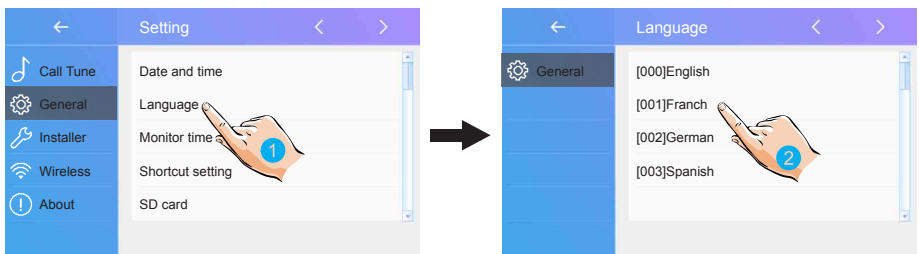

1. Touch it to enter the language interface.
2. Select the target language, and then touch it to confirm.

*If the target language is not found in the window, touch > icon to scroll next interface.

Setting monitor time

The monitor time can be changed at any time. It's available to set 30s, 60s, 90s, 120s, 150s, 180s, 210s, 240s, 270s, 300s.

* 30s is the default monitor time.

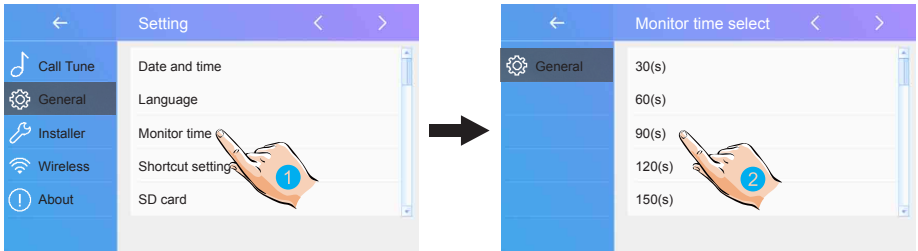

1. Touch it to enter the monitor time select interface.
2. Select the monitor time you want, and then touch it to confirm.

Shortcut setting

In this section it is possible to select the 4 quick actions that will appear on the home interface.

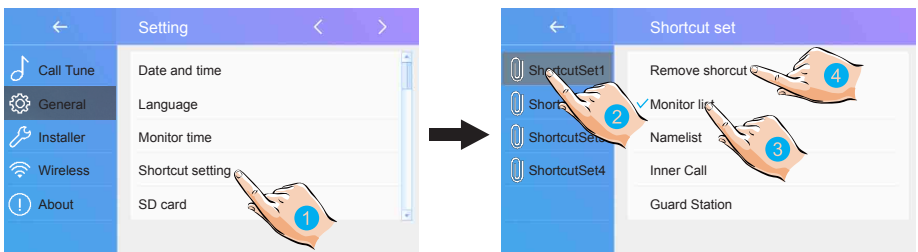

1. Touch it to enter the shortcut set interface.
2. Select the shortcut set item you want.
3. Select the type of function for which you want to add a quick action.
4. Remove the quick action from the home interface.

SD card

If the device insert an SD card, the SD card info can be reviewed on the device.

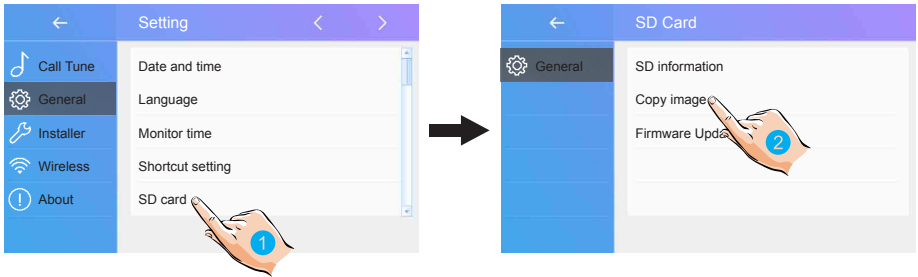

1. Touch it to enter the SD card interface.
2. Select the item you want, and then touch it to confirm.

SD information:SD card capacity.

Copy image: touch it to copy the recorded images to SD Card.

Firmware Update: update the device firmware.

Restoring to default setting

The restore to default function allows the user to recover the settings to factory setting.

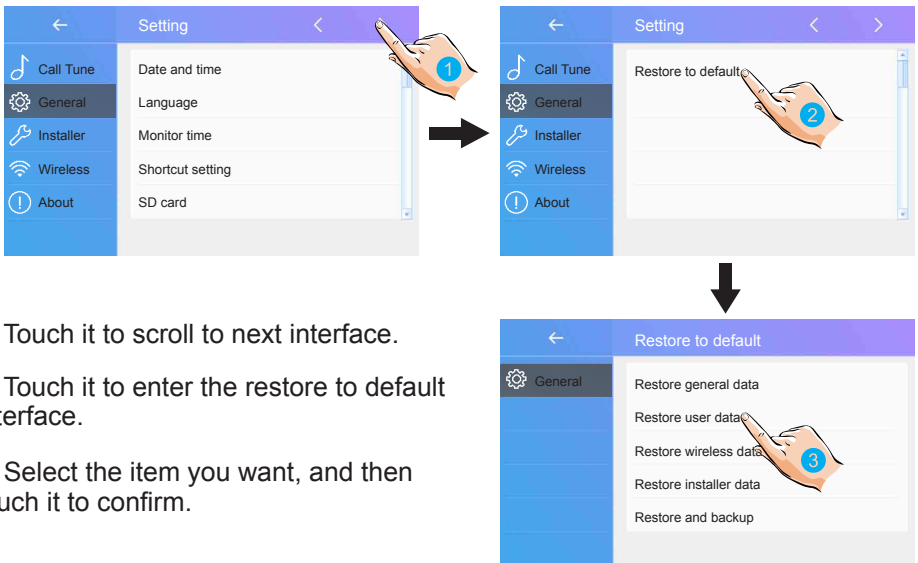

1. Touch it to scroll to next interface.
2. Touch it to enter the restore to default interface.
3. Select the item you want, and then touch it to confirm.

Installer setting

This section contains the device address setting and system settings.

1. Touch it to enter installer setting interface.

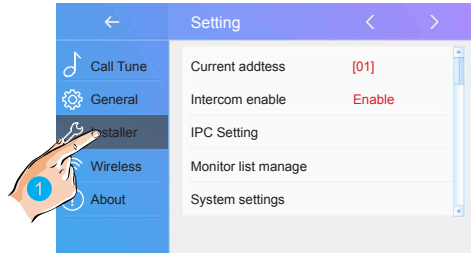

DIP Switcher Set Address

The DIP switches are used to set the user code for each monitor. Total 6 bits can be configured.

- Bit-1 to Bit-5 are used for user code setting. The value range is from 0 to 31, which have 32 different codes for 32 apartments.
- When multi monitors need to be installed in one apartment, these monitors should use the same user code, and the master/slave mode should be set on the monitor. (Details refer to the section of **Setting Slave Monitor**)
- Bit-6 is bus line terminal switch, which should be set to “ON” if the monitor is at the end of bus line, otherwise be set to “OFF”.

Bit-6 switch setting

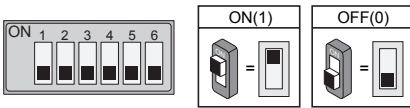

Bit state	Setting	Bit state	Setting
	When monitor is not at the end of bus line.		When monitor is at the end of bus line.

This monitor is assigned with DIP setting instructions. Total 32 DIP codes.

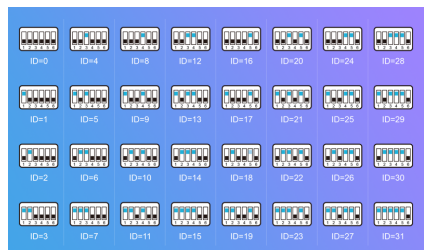
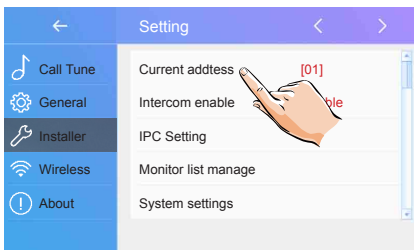

Enabling/Disabling intercom function

It's available to forbid or activate the intercom function.

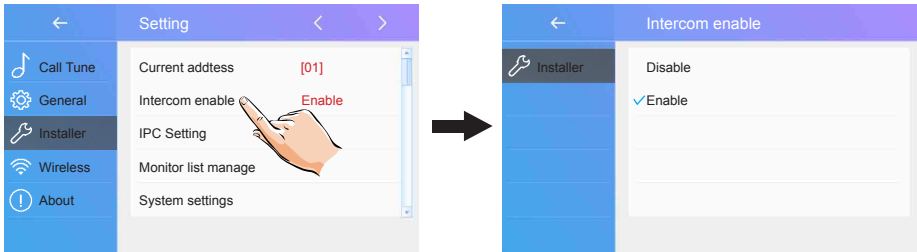

*In default setting, intercom function is enable for the monitor.

IPC Setting

It's available to set the related function of IP camera.

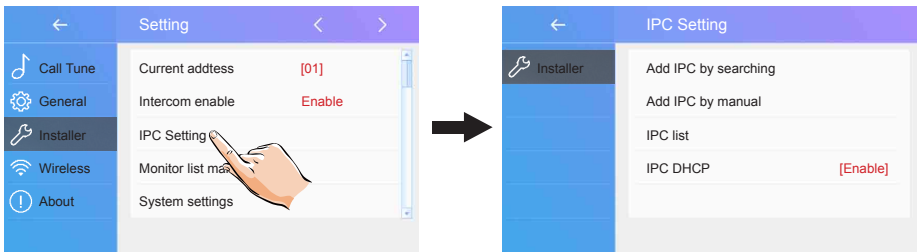

Add IPC by searching: Add the IP camera by searching online.

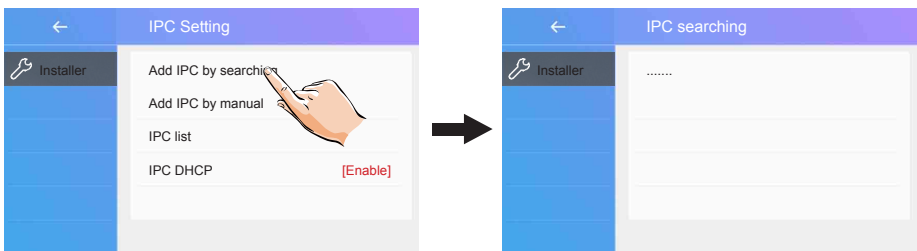

Add IPC by manual: Add the IP camera by manual.

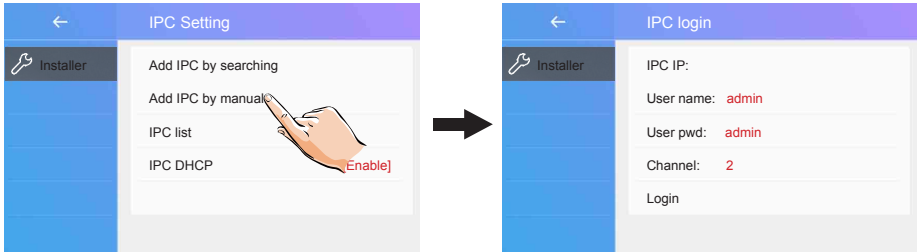

IPC list: IP camera list.

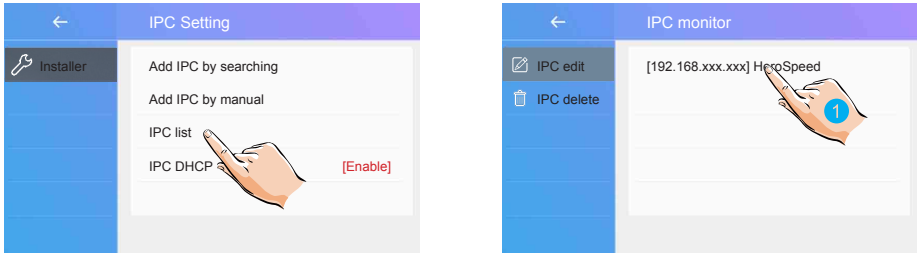

1. Touch it to edit the IP camera's name.

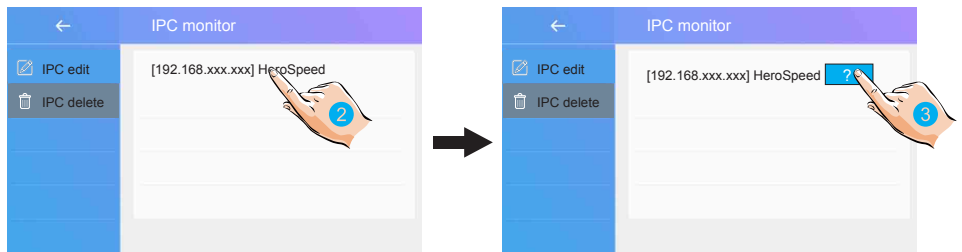

2. Touch it to enter delete the IP camera status.
3. Touch it to delete the IP camera.

IPC DHCP:It's available to forbid or activate the IPC DHCP.

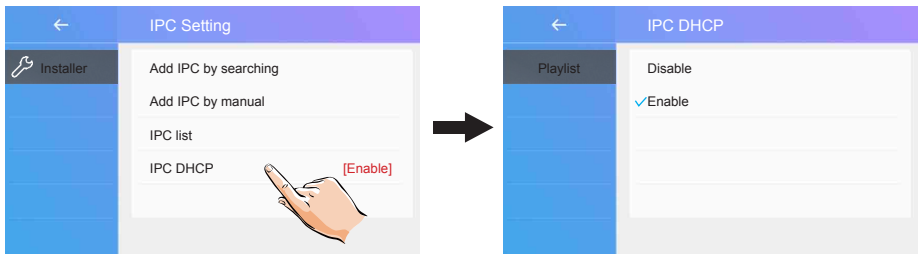

Monitor list manage

It's available to manage the monitor list.



[X] means the function is available;
[-] means the function is off and unavailable.

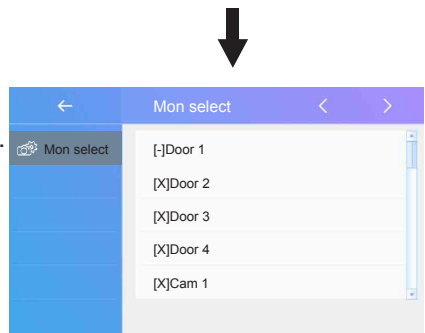

System setting

This section will be reserve.

Software upgrade

It's available to upgrade the device software via SD card.

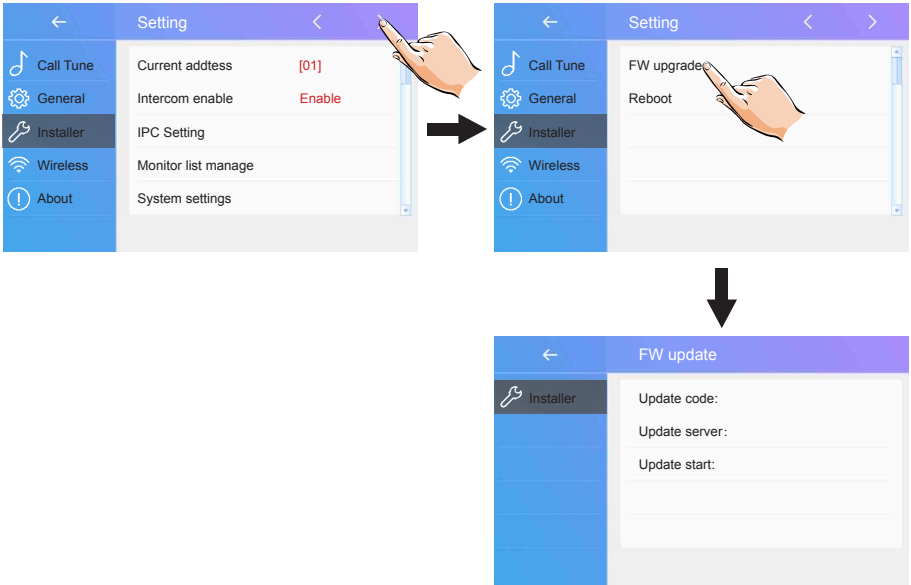

Reboot

It's available to reboot the device.

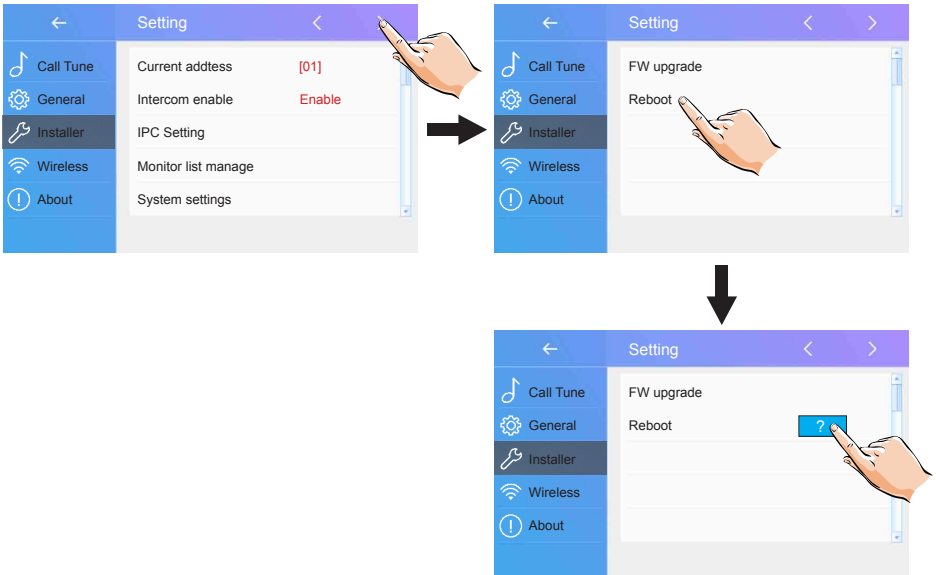

Wireless setting

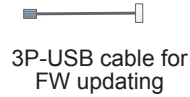
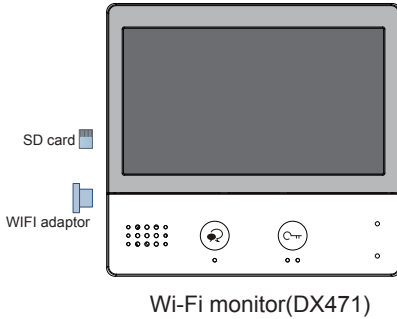

1. Touch it to enter wireless setting interface.
2. Touch it to activate the function, make sure the switch is ON.
3. Touch it to enter wlan setting interface.
4. Touch it to scroll the interface.
5. Touch it to select the domestic network to which you want to connect the device.
6. Touch it to enter the input password interface.

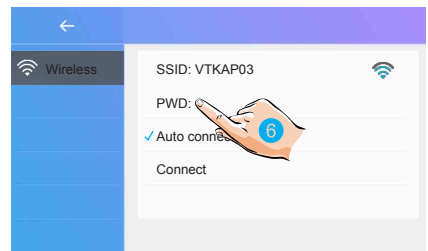
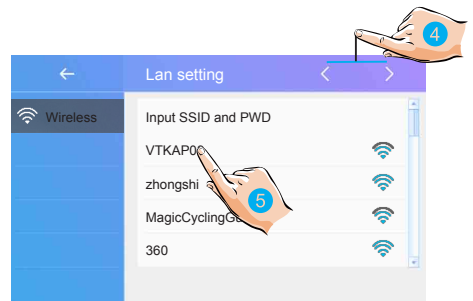
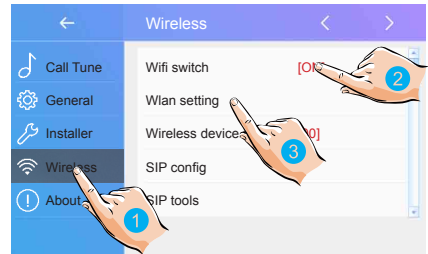

7. Enter the password (if required).

8. Touch it to activate the connection, and return to Wi-Fi information interface.

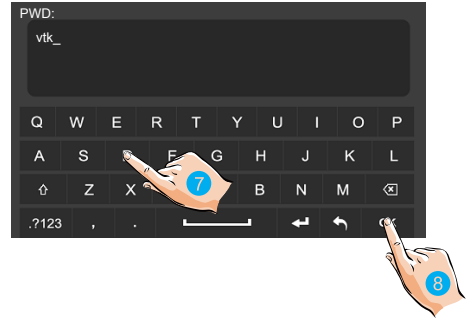

9. Go to Connect/Disconnect item.



Make slave Wi-Fi monitor to be registered with master Wi-Fi monitor

On master Wi-Fi monitor and slave Wi-Fi monitor, go into wireless setting interface.

1. Touch it to enter the device manage interface.

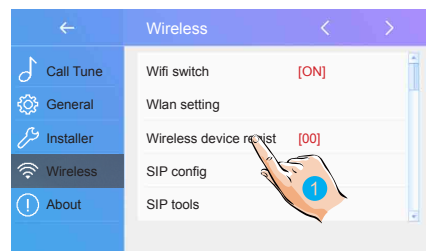

2. Touch it to enter the master / slave register interface.

master Wi-Fi monitor

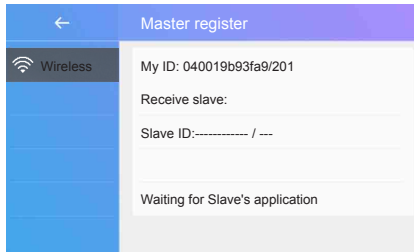
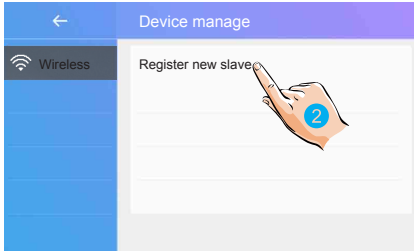

slave Wi-Fi monitor

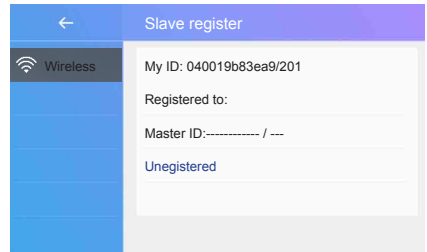
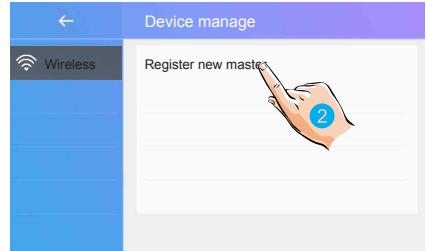

SIP config

It's available to divert the call to mobile while out of home via SIP server.

On the call scene interface

1. Touch it to select the divert call mode:
Divert Call If No Answer or Divert Call
Always.

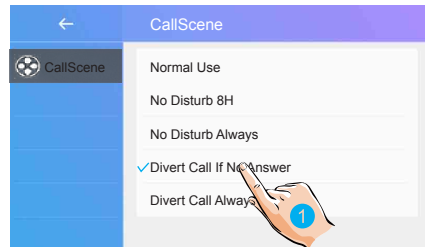

On the wireless setting interface

2. Touch it to enter the SIP config.



3. Touch it to restore all settings on “SIP config” and create 2 SIP accounts, one for DX monitor and one for 2Easy APP. Server will apply to restore two accounts’ password to default, and register it. Only when:

- If your DX monitor is not brand new, we suggest you touch “Use default” before testing.
- 2Easy APP is not able to register on server

4. Touch it, DX monitor will apply to clean all SIP “contact” on server, and also will try to register itself to server, with this function it will helps when:

- 2Easy APP is not able to get push notification.
- DX monitor has connect with Wi-Fi, but “Server” icon with “!” or “x” beside.

SIP tools

SIP tools could test divert function and with an unattended door station.

1. Touch it to enter the SIP tools page.

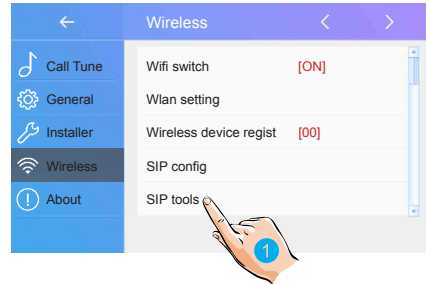

2. While if your test with pressing door station doesn't work well, you could also try with auto-test. Touch it to enter call testing page.

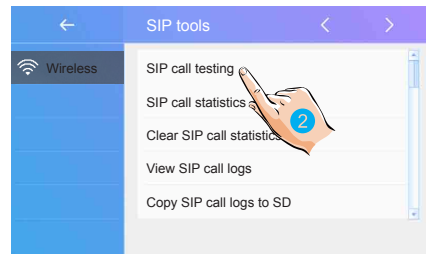

- "SIP call testing count" from 1 to 99, means test automatically 1-99 times;
- Set "Call interval" from 1 to 10 min, means system will wait 1-10 min between 2 calling;
- Keep "Retry timing" as default, 12sec
- Set "Video quality" to 0, means lowest required to network;

3. After all settings have done, touch "Start SIP call testing", DX monitor will immediately divert a calling to mobile.

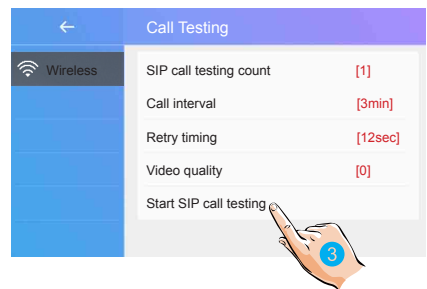

In SIP tools page, you can also know the items "SIP call statistics", "Clear SIP call statistics", "View SIP call logs", "Copy SIP call logs to SD", "View registered Phones".

About

1. Touch it to enter about interface.

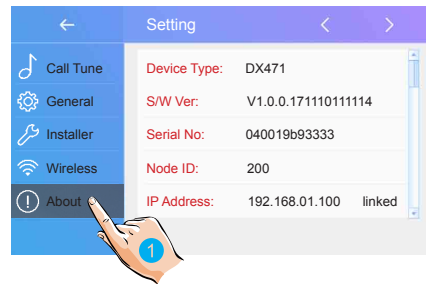

Device Type: the device name.

S/W Ver: the software version.

Serial No: the device serial number.

Node Id: Node ID number.

IP Address: the device IP address.

H/W Address: the device Mac address.

Subnet Mask: the device subnet mask.

Default Route: the device default route.

DT Address: the device code number.

M/S Code: show the device is a master monitor or sub monitor.

Online: show the numbers of sub monitor.

13. Download Setup 2Easy APP

1. Scan and download 2Easy APP, or search “2Easy” on APP store.

IOS



Android



2. Permit “2Easy” with internet access and camera, on DX monitor, press “SIP Server” icon on main menu, and keep in “SIP config”, on 2Easy APP, press on top-right, to scan QR code on DX monitor, and press “Save”.

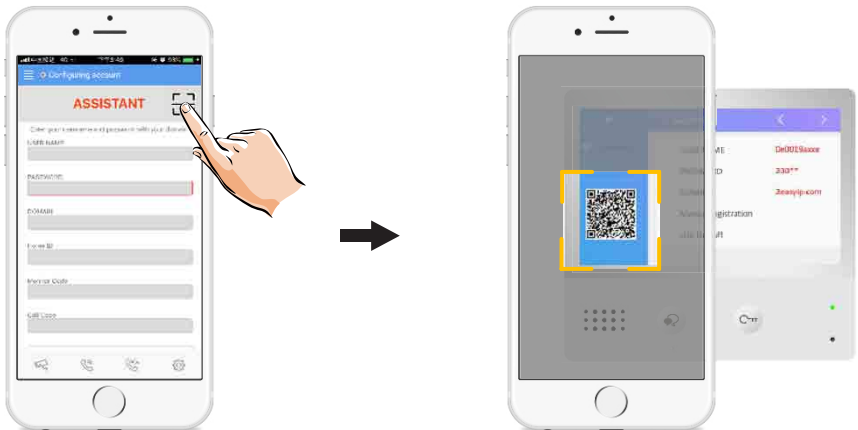

3. Disable “IPV6” on 2Easy APP

Most of internet provide doesn't support IPV6 feature, please manually disable it with follow steps:

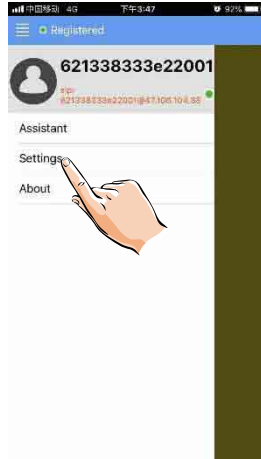
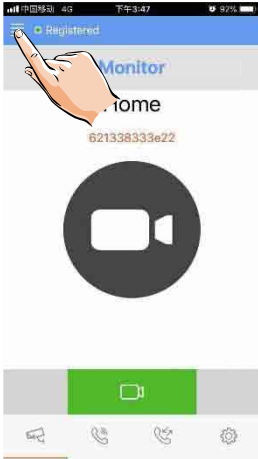

Press here to disable

4. After login SIP account on 2Easy APP, check on status bar, or press on the “Registered” area to manually register, until 2Easy APP display:

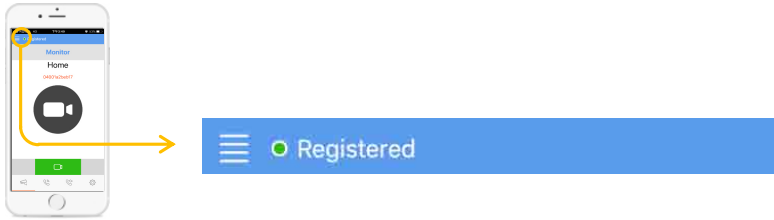

14. Surveillance door station via 2Easy APP

On 2Easy APP, press on “Monitor” and wait for a few second (Due to 2-Wire communication will take around 12 second to get video), blue screen is normally due to the DX monitor is verifying the password and monitor code.

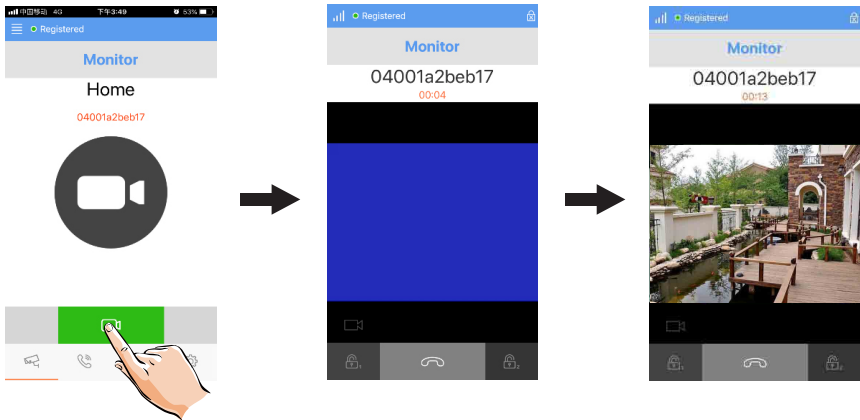

15. How It Works

Two working modes

There are 2 working modes depend on whether your mobile phone is covered with same Wi-Fi network or not, and DX master monitor can be regarded as a gateway device.

Local mode--at home with same Wi-Fi network

- No need SIP sever and account log in
- Both Wi-Fi sub Monitor and Phone in Local mode work as wireless slave monitors

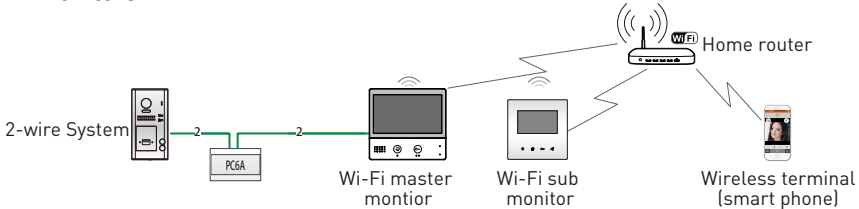

In case of calling, Wi-Fi sub Monitor and Phone will ring simultaneously, one device answer the call will make others turn off automatically.

Divert mode--away from home with call divert

- SIP server and account are a must(A factory account is preset)

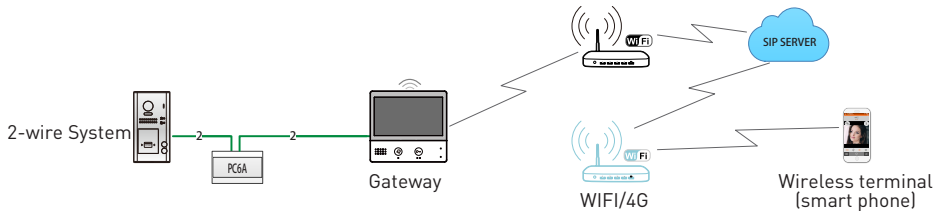

- Call scenes(No disturb / If no answer / Divert always) in away home

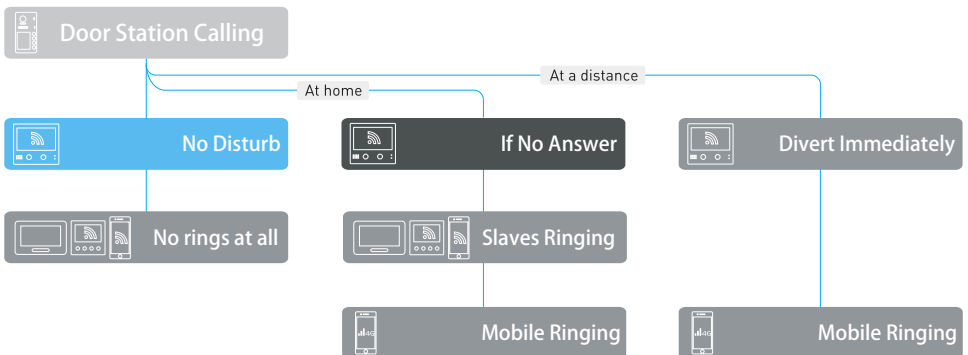

Note: Any one off hook, others will be closed automatically.

16. Specification

- Power supply: DC 20~28V
- Power consumption: Standby 1.8W; Working 8.16W
- Monitor screen: 7 Inch digital color TFT
- Display Resolutions: 800*3(R, G, B) x 480 pixels
- Video signal: 1Vp-p, 75Ω, CCIR standard
- Wiring: 2 wires, non-polarity
- Dimension: 161(H)×174(W)×22(D)mm

17. Precautions

- 1) All components should be protected from violence vibration. And not allow to be impacted, knocked and dropped.
- 2) Please do the cleanness with soft cotton cloth, please do not use the organic impregnant or chemical clean agent. If necessary, please use a little pure water or dilute soap water to clean the dust.
- 3) Image distortion may occur if the video monitor is mounted too close to magnetic field e. g. Microwaves, TV, computer etc.
- 4) Please keep away the monitor from wet, high temperature, dust, caustic and oxidation gas in order to avoid any unpredictable damage.
- 5) Must use the right adaptor which is supplied by the manufacturer or approved by the manufacturer.
- 6) Pay attention to the high voltage inside the products, please refer service only to a trained and qualified professional.