

2 WIRE INTERCOM SYSTEM

DT17S-D7

7" COLOR TFT MONITOR

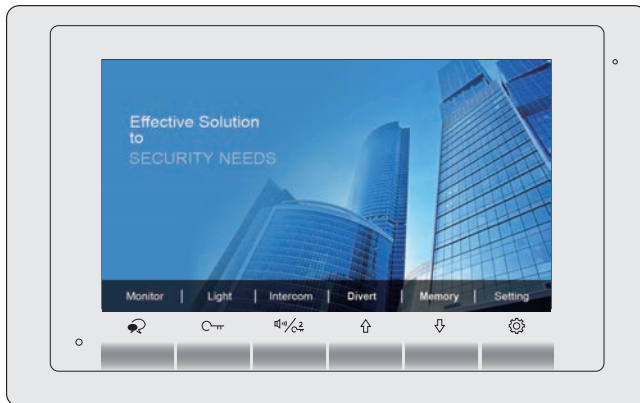

- Please read this manual carefully before using the product you purchase, and keep it well for future use.
- Please note that images and sketch maps in this manual may be different from the actual product.

CONTENTS

1. Part And Functions	1
2. Mounting	3
3. Main Menu	3
4. Basic Door Release Operation	4
5. Intercom Function	4
6. Opening Staircase Light	6
7. Memory	6
8. Divert Call	7
9. Basic Setup Instructions	8
10. Monitor Parameter Setting	10
11. Basic Connection	14
12. Specification	15
13. Precautions	15

1. Parts and Functions

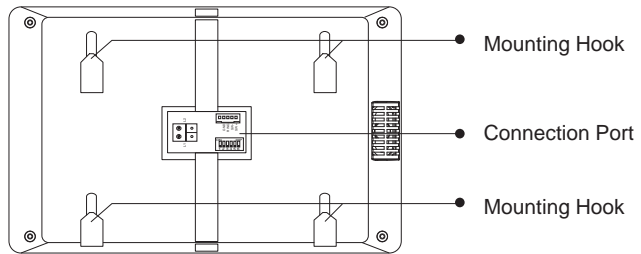
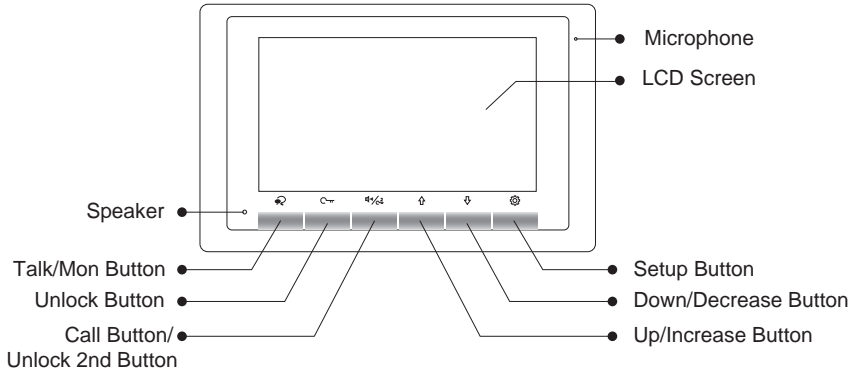

Key functions

Microphone	Receive voice from the user.
LCD screen	Display the visitors' image.
Setup button	Press to select the setting item you want.
Down/Decrease button	Press to decrease the value.
Up/Increase button	Press to increase the value.
Speaker	Send out voice from the visitor.
Talk/Mon button	Press to communicate hands free with visitor; Press to view the outdoor condition in standby mode.
Unlock button	Press to release the door
Call button/Unlock 2nd button	In standby mode, pick up handset, then press Call button to activate the inner call; During calling/talking state, press Unlock 2nd button to release the second door.
Mounting hook	Use to hang up the monitor.
Connection port	Bus terminal.

Terminal Description

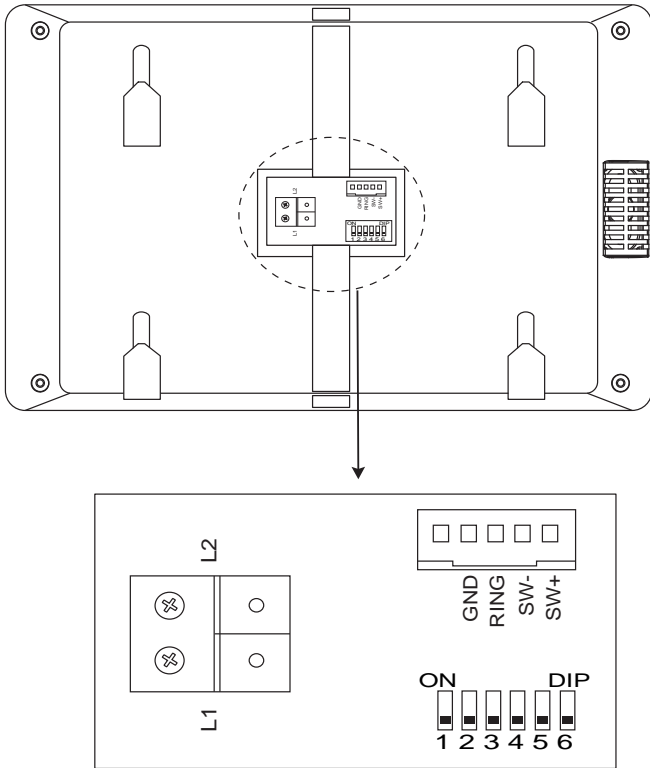

SW+,SW-: Extra door bell call button connection port.

RING,GND: Extra buzzer connection port.

L1,L2: Bus terminal.

DIP switches: Total 6 bits can be configured.

Bit1~Bit5: Used to User Code setting.

Bit6: Video impedance matching switch.

2. Mounting

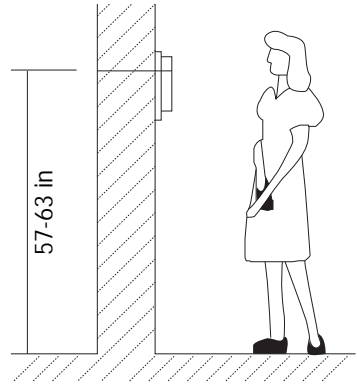
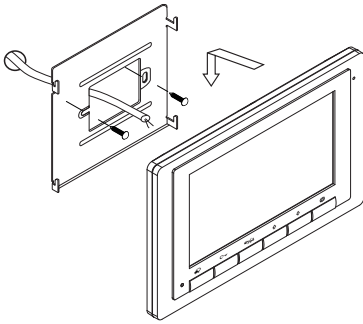

Use the screws to fix the Mounting Bracket on the mounting box.(fitting accessories includes a Bracket (Two pieces of 4X25 screws are needed for fastening the Mounting Bracket), Special 2 wire connectors to connect with Monitor)

Wire the system correctly(see the later connection chapter) then hang the Monitor on the Mounting Bracket firmly.

3. Main Menu

The Main menu is your starting point for using all the applications on your monitor.







Press **Setup** button, or **Down** button, or **Up** button in standby mode, the Main menu will appear as follow:



* 1. If you want to activate **Divert** and **Memory**, DT-IPG should be connected to the system.

2. Current date and time: You can also synchronize the system time via clock server. Please refer to the related manual for detailed instructions.

4. Basic Door Release Operation

1. Press **Call** button on outdoor station, the Monitor rings, at the same time, the screen displays the visitors' image.
2. Press  **Talk/Mon** button on monitor, you can communicate hands free with the visitor for 90 seconds. After finishing communication, press  **Talk/Mon** button again to end the communication. If nobody answers the phone, the screen will be turned off automatically after 40 seconds.
3. During talking state, Press  **Unlock** button to open the door for the visitor.(if two locks are connected to door camera, press  **Unlock 2nd** button to release the second lock)
4. When the monitor is in standby mode, press  **Talk/Mon** button, the screen can display the view of outside. At this time, if multi door stations are installed, you can use  button to switch the door station or CCTV camera you want.







5. Intercom Function

It is available to call between monitors in the same room or in the same system,or call the Guard Monitor. Follow the steps to activate the functions:

Calling other monitors in the same system

Please note this Intercom Call can be activated by inputting code 9015, or be deactivated by inputting code 9016, see page 10-11.

- (1)When the monitor is in standby mode, press  **Setting** button to enter main menu page.
- (2)Press  **Call button/Unlock 2nd** button to enter **Intercom** page.
- (3)Press  **Call button/Unlock 2nd** button again to enter **Intercom Call** page.
- (4)Select the building number and room number you want, and then press  **Talk/Mon** button to call the corresponding user.
- (5)Intercom calling. If the call is answered,conversation is activated.



*Note:

1. Press **Call button/Unlock 2nd** button on panel in standby mode to enter **Intercom** page in shortcut.
2. If the DT-IPG connected to the system, the system support 8-digit input, 4-digit building number, 4-digit room number, each can be individually changed. If not, you can only input 2-digit room number, the range is 01~32, otherwise the system will prompt error.
3. The system will automatically displays the last dial number when enter the dial-up interface.
4. The mode of building/room number must be 4-digit(such as 5678) or 2-digit(such as 89), do not allow the middle space(such as 12 3), otherwise the system will prompt error.

Calling monitors in the same room

- (1)When the monitor is in standby mode, press **Setting** button to enter main menu page.
- (2)Press **Call button/Unlock 2nd** button to enter **Intercom** page.
- (3)Press **Up** button to activate **Inner Call**.
- (4)Inner calling. all other monitors in the same room will ring at the same time, whichever monitor answers the call, conversation is started, other monitors will stop ringing at once. (Calling ends automatically after 30 seconds if nobody answers the call)



Calling the guard monitor

A Monitor can be assigned as Guard Unit Monitor.

- (1)When the monitor is in standby mode, press **Setting** button to enter main menu page.
- (2)Press **Call button/Unlock 2nd** button to enter **Intercom** page.
- (3)Press **Down** button to activate **Guard Unit**.

(4)Guard unit calling. when the Guard Unit Monitor answers the call, conversation with the guard person is started.



6. Opening Staircase Light

Note: The staircase light should be connected on the system, and this function should be supported by RLC. Please refer to RLC user instruction in detail.

Press **Unlock** button on main menu page to open the staircase light, the staircase light will be turned off automatically after 60 seconds.

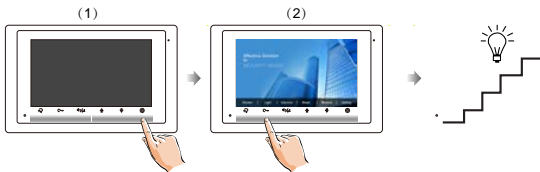

*Press **Unlock** button again to turn off the light.

7. Memory

The recorded images/videos can be playback on monitor. please note that this function should be supported by the unit of IPG.

You can also delete the images/videos. Follow the steps:

- (1)When the monitor is in standby mode, press **Setting** button to enter main menu page.
- (2)Press **Down** button to enter **Memory** page.
- (3)Press **Talk/Mon** button to activate **Delete** item, and it will show "?" on the screen.
- (4)Press **Talk/Mon** button again to delete this image/video.
- (5)Delete this image/video finally.

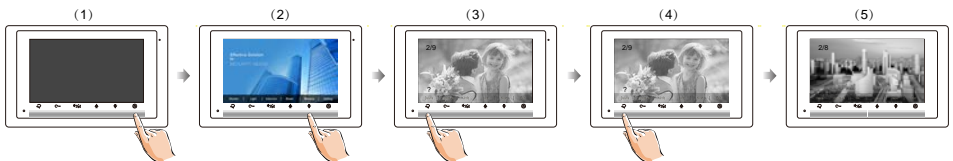

8. Divert Call

The calling from door station can be diverted to your phone. please note that this function should be supported by the unit of IPG.

Three modes can be selected.

1. No Divert: Calls from outdoor station will not be diverted.

2. Divert, If No Answer: If nobody answers the call in 30s when receives call from door station, diverts the call to the phone.

At this mode, the monitor will shut off the screen after diverting successfully, but you can still use it in normal.

3. Divert, Simultaneously: When receives call from door station, diverts the call to the phone immediately.

At this mode, the monitor will always open the screen and show image from door station during diverted, if the monitor answers the call at this time, diverted will conclude at once.

Follow the steps to activate this function:

(1)When the monitor is in standby mode, press  **Setting** button to enter main menu page.

(2)Press  **Up** button to enter **Divert** page.

(3)Follow the instructions to select the item you want.

(4)After the call mode is selected, it returns to the last menu.



Note:

* The status bar on main menu page will show "  " icon.

* The time limited with the phone is 90s.

If you want to know the divert account information, follow the steps:



Function status

	SIP server connection active and configured
	SIP server connection disabled
	SIP server connection active and not connected

9. Basic Setup Instructions

Door station call tone setting

- (1) When the monitor is in standby mode, press **Setting** button to enter main menu page.
- (2) Press **Setting** button again to enter **door station call tone** setting page.
- (3) Use / button to select the tone you want.







Inercom call tone setting

- (1) When the monitor is in standby mode, press **Setting** button to enter main menu page.
- (2) Press **Setting** button twice to enter **intercom call tone** setting page.
- (3) Use / button to select the tone you want.







Door bell tone setting

- (1)When the monitor is in standby mode, press  **Setting** button to enter main menu page.
- (2)Press  **Setting** button three times to enter **door bell tone** setting page.
- (3)Use  /  button to select the tone you want.







Tone volume setting

- (1)When the monitor is in standby mode, press  **Setting** button to enter main menu page.
- (2)Press  **Setting** button four times to enter **tone volume** setting page.
- (3)Use  /  button to select the volume level you want.









Restore to default

- (1)When the monitor is in standby mode, press  **Setting** button to enter main menu page.
- (2)Press  **Setting** button five times to enter **restore to default** setting page.
- (3)Use  /  button to activate restore to default.



Change date & time & Time Zone

- (1) When the monitor is in standby mode, press  **Setting** button to enter main menu page.
- (2) Press  **Setting** button five times to enter **restore to default** setting page.
- (3) Press and hold  **Unlock** button for 3s.
- (4) Use , ,  button to change the value you want.

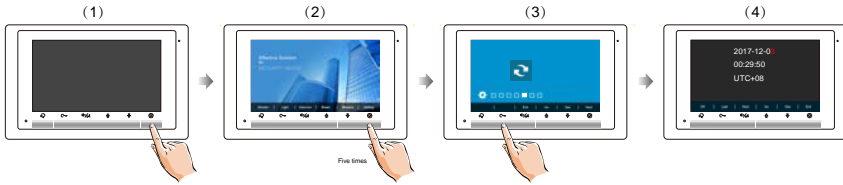

Screen and volume adjustment

During monitoring or talking state, press  Setup Button, the Adjust page will be displayed.

The Scene mode selection: Total 4 screen modes can be selected in sequence. Select the item you want to set.

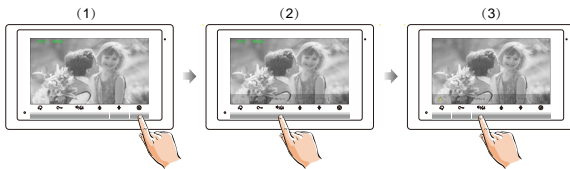



10. Monitor Parameter Setting

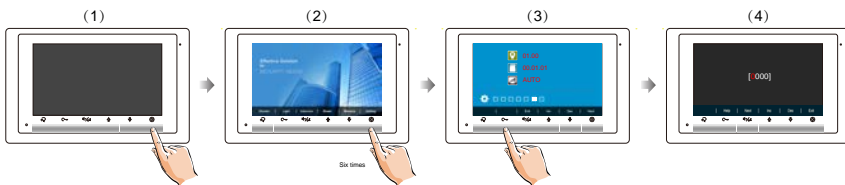

How to enter the installation setting page



1. Press  **Setting** button in standby mode.

2. Press  **Setting** button six times.

3. Press and hold  **Unlock** button for 3s.

4. Use  /  button to increase / decrease the value; use  button to select next digital.

*Note: Press and hold  **Setting** button for 3s on panel in standby mode to enter the installation setting page in shortcut.

How to know the machine code

When you want to set the monitor parameter, you must to know the setting code.



1. Press **Unlock (Help)** button in installation setting page.

4. Use **Search** button to search the code you want.

■ The setting items and codes are as followings

Code	Setting Item	Code	Setting Item
2419	Reset To Default	8018-8020	Video Format
2414	RM Parameter Set	8401-8499	Unlock Time
3006-3600	Monitor Time	9015-9016	Intercom On/Off
8008-8009	Date Mode	9017-9018	Memory On/Off
8010-8011	Unlock Mode:Close/Open	9101-9104	DS Quantity
8012-8013	Time Mode	9200-9216	Cam Quantity
8016-8017	Bypass Setting		

How to set the slave monitor address

Maximum 4 monitors can be connected in one apartment, one master monitor together with 3 slave monitors, so you should set the address correctly. (note: must have one monitor to be set as master monitor)

The code of 8000 is used to set the master monitor.

The code of 8001 is used to set the first slave monitor .

The code of 8002 is used to set the second slave monitor .

The code of 8003 is used to set the third slave monitor .

How to set date and time format

The system offers two methods of date and time.

The code number of 8008 is used to set the date format as month/date/year

The code number of 8009 is used to set the date format as date/month/year

The code number of 8012 is used to set the time format as 12 hour system

The code number of 8013 is used to set the time format as 24 hour system

How to set the monitor panel on

In default mode,when receive a calling,the master and slave monitors will ring at the same time,and just the master monitor can display the image while the slave monitors can not.But the settings can be changed,you can set the master monitor and all the slave monitors to panel on at the same time when receiving a call, just input the code number of 8006 on each slave monitor.



How to set the unlock parameter

Unlock mode:

There are two unlock modes: 1.power-on- to-unlock type:unlock mode=0(by default)

2.power-off-to-unlock:unlock mode=1.

The code number of 8010 is used to set the unlock mode to 0

The code number of 8011 is used to set the unlock mode to 1

Unlock time:

The unlock time can be changed by yourself at any time. it can be set from 1 to 99 seconds.

The code number from 8401 to 8499 are used to set the unlock time to 1~ 99 seconds.

■ Entering address form page

With a tool to Toggle one of the DIP(1-5) to open **Address Setting** page.

Refer to the followings:

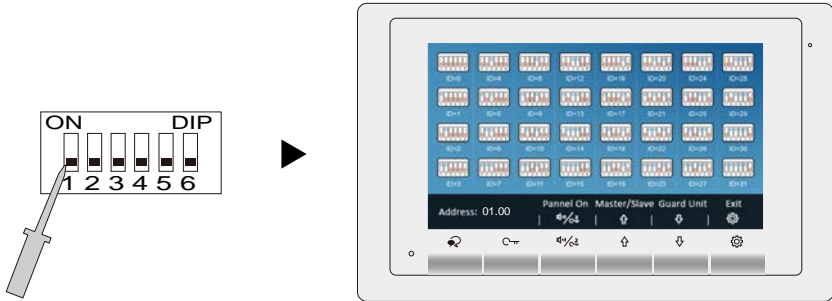

How to set the user code for the monitor

In the DT system, every apartment must have a unique identification called User Code. The DIP switches are used to configure the User Code for each Monitor.

- Bit-1 to Bit-5 are used to User Code setting. The value is from 1 to 32, which have 32 different codes for 32 apartments.
- When multi Monitors are installed in one apartment, these Monitors have to use the same User Code setting, and the Master/Slave mode should be set on the Monitor.
- Bit-6 is line terminal switch, which have to be set to ON if the Monitor is in the end of the line(bus), otherwise set to OFF. The end of the line is terminal that no other section will start from it.

Bit-6 line terminal setting:

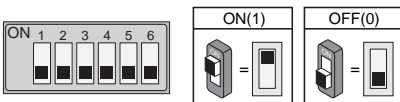

Bit state	Setting	Bit state	Setting
<p>ON 1 2 3 4 5 6</p>	Monitor not at the end of the line.	<p>ON 1 2 3 4 5 6</p>	Monitor at the end of the line.

Bit state	User Code	Bit state	User Code	Bit state	User Code
	Code=1		Code=12		Code=23
	Code=2		Code=13		Code=24
	Code=3		Code=14		Code=25
	Code=4		Code=15		Code=26
	Code=5		Code=16		Code=27
	Code=6		Code=17		Code=28
	Code=7		Code=18		Code=29
	Code=8		Code=19		Code=30
	Code=9		Code=20		Code=31
	Code=10		Code=21		Code=32
	Code=11		Code=22		

11. Basic Connection

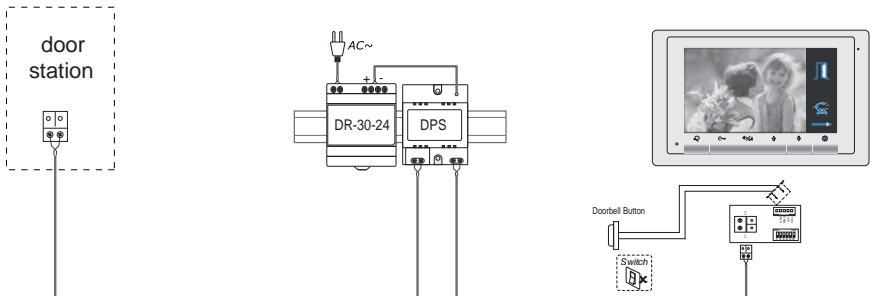

12. Specification

- Power supply for indoor monitor: DC 20~28V
- Power consumption: Standby 6.6mA; Working 240mA
- Monitor screen: 7 Inch digital color LCD
- Display Resolutions: 800*3(R, G, B) x 480 pixels
- Video signal: 1Vp-p, 75Ω, CCIR standard
- Wiring: 2 wires, non-polarity
- Dimension: 5.51(H)×8.66(W)×0.69(D) inch

13. Precautions

- 1) All components should be protected from violence vibration. And not allow to be impacted, knocked and dropped.
- 2) Please do the cleanness with soft cotton cloth, please do not use the organic impregnant or chemical clean agent. If necessary, please use a little pure water or dilute soap water to clean the dust.
- 3) Image distortion may occur if the video monitor is mounted too close to magnetic field e. g. Microwaves, TV, computer etc.
- 4) Please keep away the monitor from wet, high temperature, dust, caustic and oxidation gas in order to avoid any unpredictable damage.
- 5) Must use the right adaptor which is supplied by the manufacturer or approved by the manufacturer.
- 6) Pay attention to the high voltage inside the products, please refer service only to a trained and qualified professional.

DT-ENG-17S/D7-V1

The design and specifications can be changed without notice to the user. Right to interpret and copyright of this manual are preserved.